

3.8V-36V V_{in} , 5A, High Efficiency Synchronous Step-down DCDC Converter with Adjustable Frequency

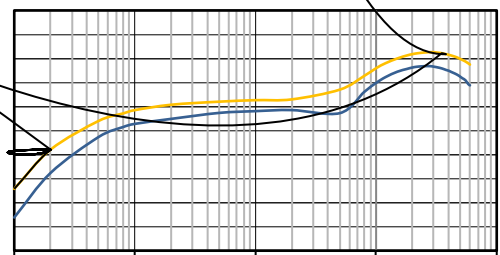

X TNGE PDE TTPNGE XMS RD

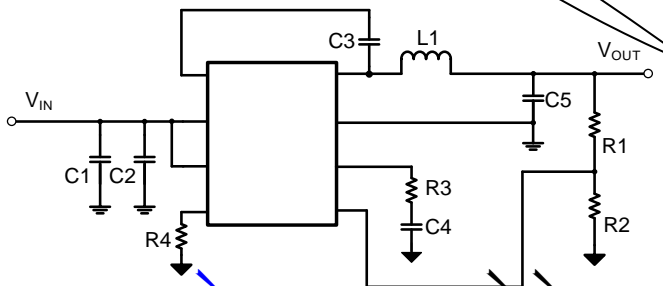

8

2

MI MRELYS V ID

MI MRELYS V ID

6

:

68 6 : 6

68 6 : 8

023.

023.

023.

MI MRELYS V ID

MI MRELYS V ID

: 8

6

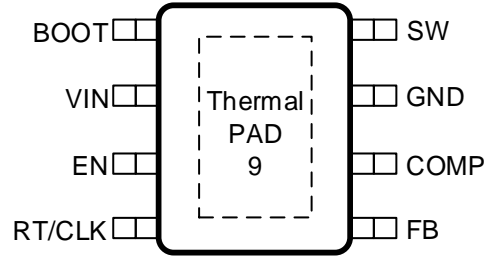

2

2

0.07

	3	
	4	

VIES PHHHTI VEX RRS RHM R D

		6	
"	1,	14	"
"	.	14	"
	±2.	/03	

I HXXXXXXXXXIA

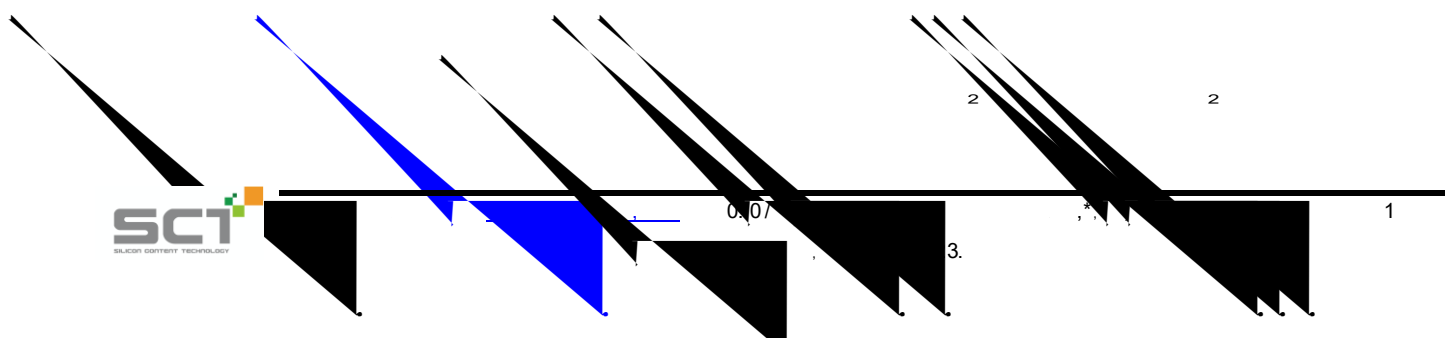

8

I PI GXVMEP... VMXMG D

" 02" * +2. / 3	03 ,		
A 6 6 : :	: 8	6	
"		1,	14 "

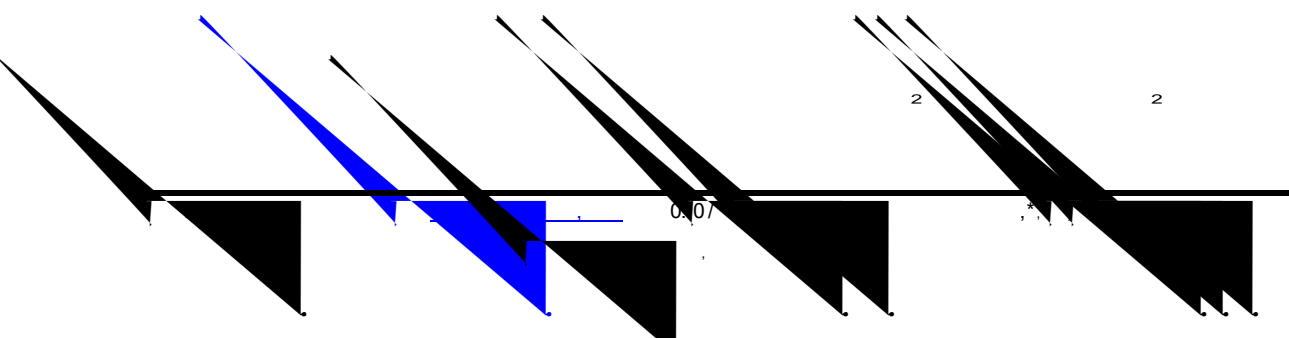

A	6 6 : :	: 8	6	
"	+	+	0,14 1..	"

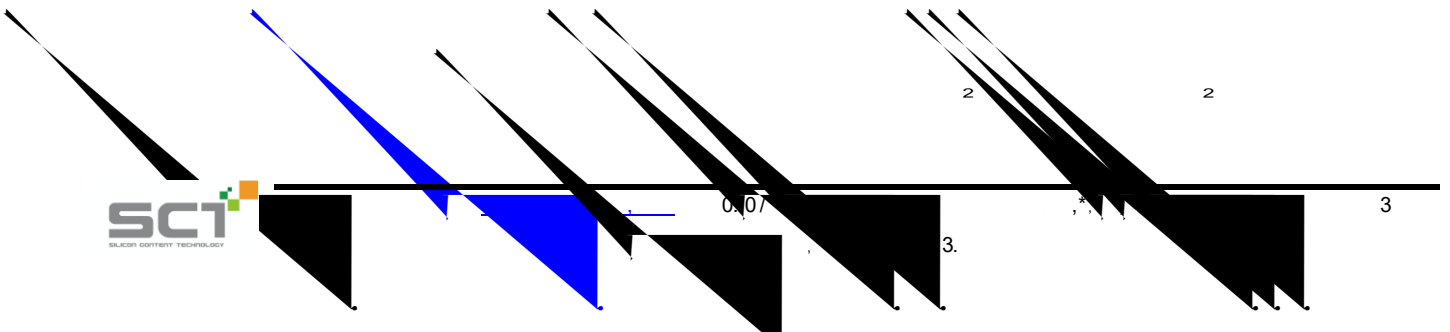

X TIME PILE VE GXI VMXNG D

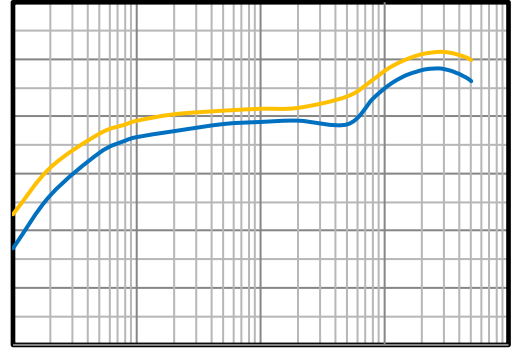
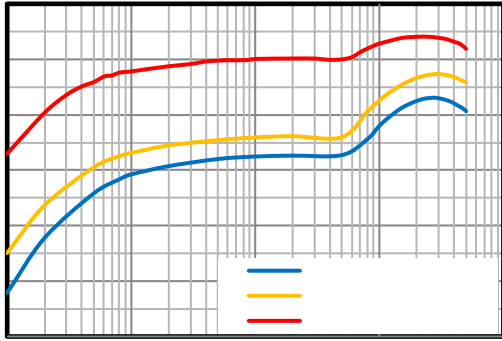

* 14



* 02

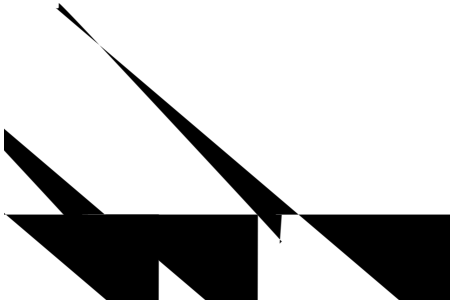

* 10

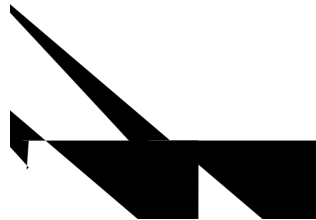

& 3

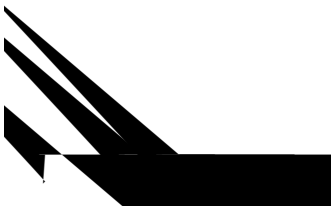

& 3

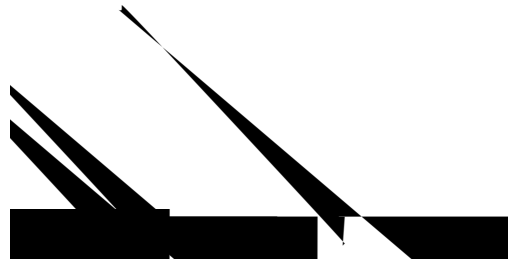

2

2

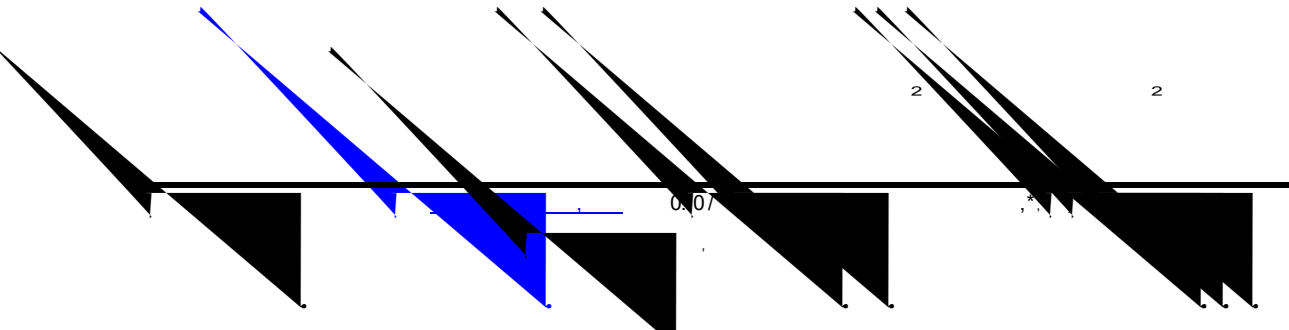

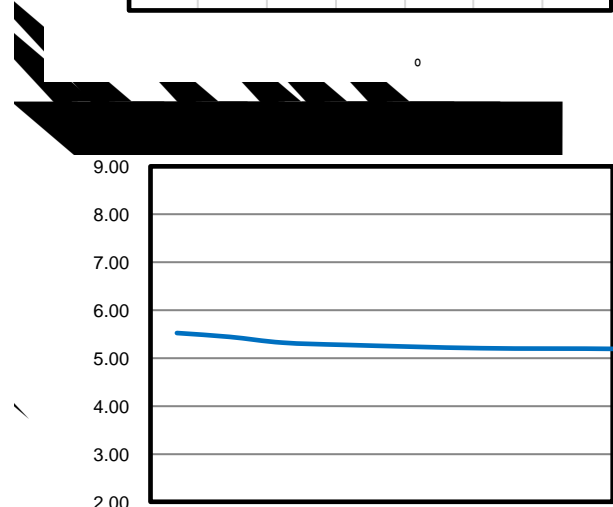
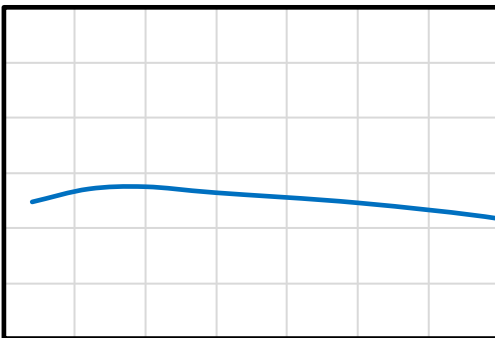
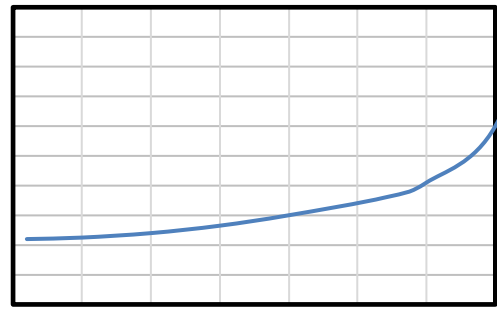
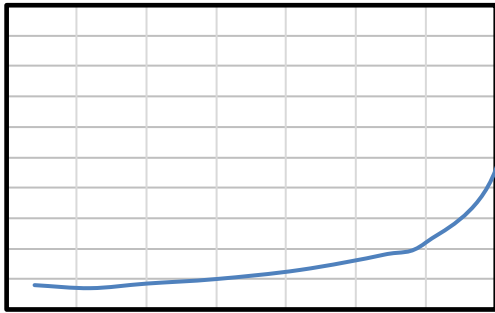

-50 -25 0 25 50 75 100 125

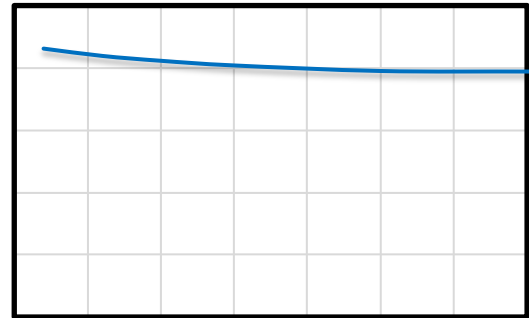
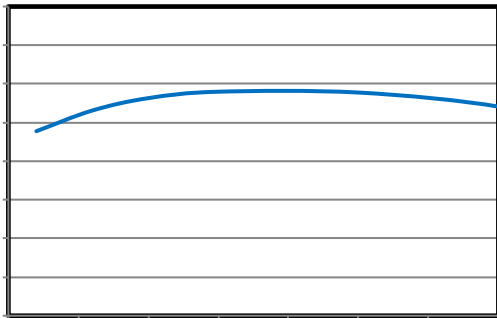

Temperature (°C)

D

D

YRGXMS RE PIF PS GODIM KVE D

D

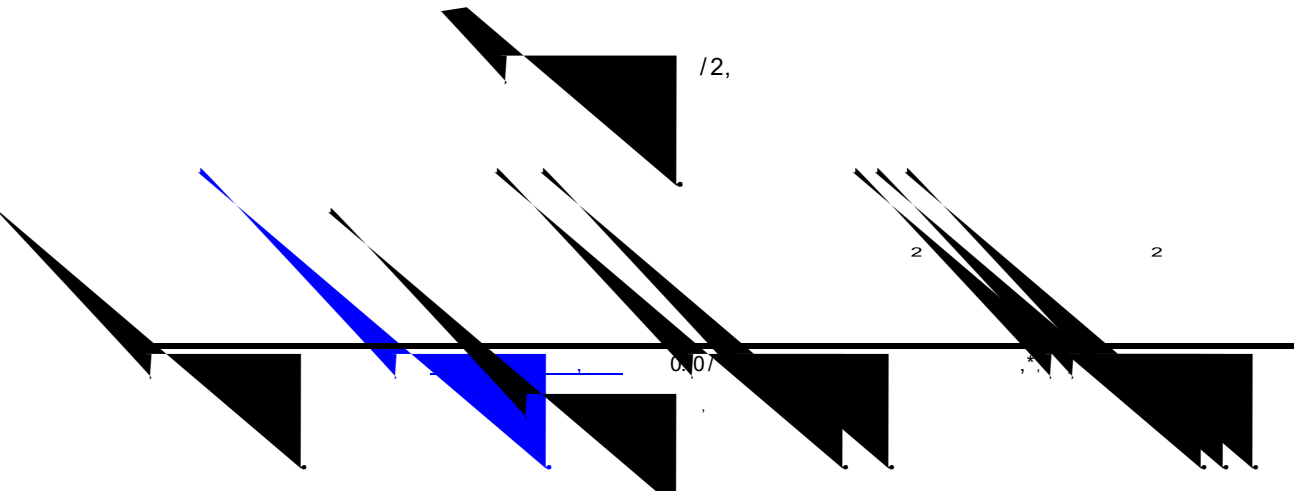
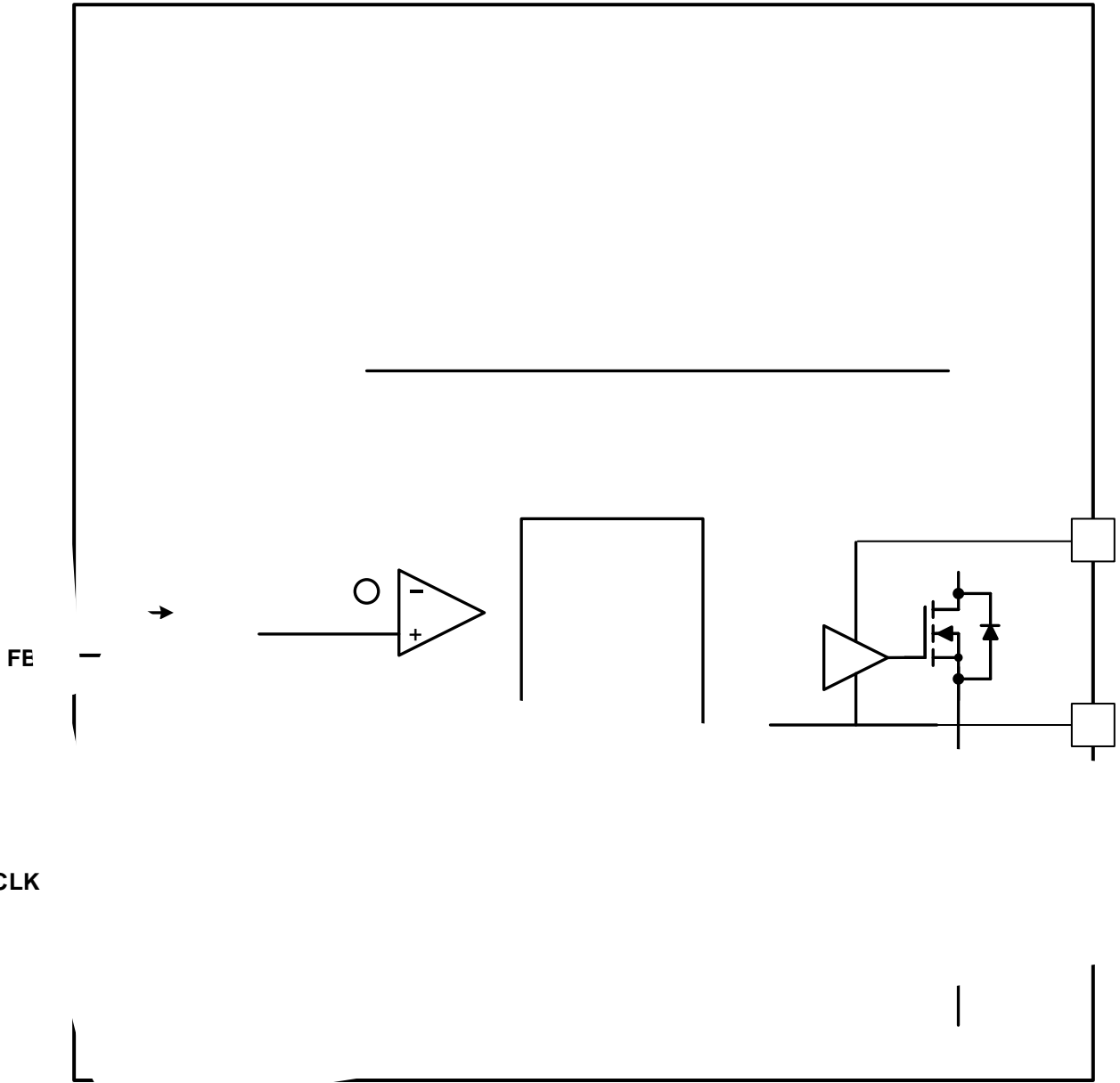

2
STIVEX RD

2

2

2

223

44"

+ 2

2

2 2

*

2
2

2 2

2

+

+

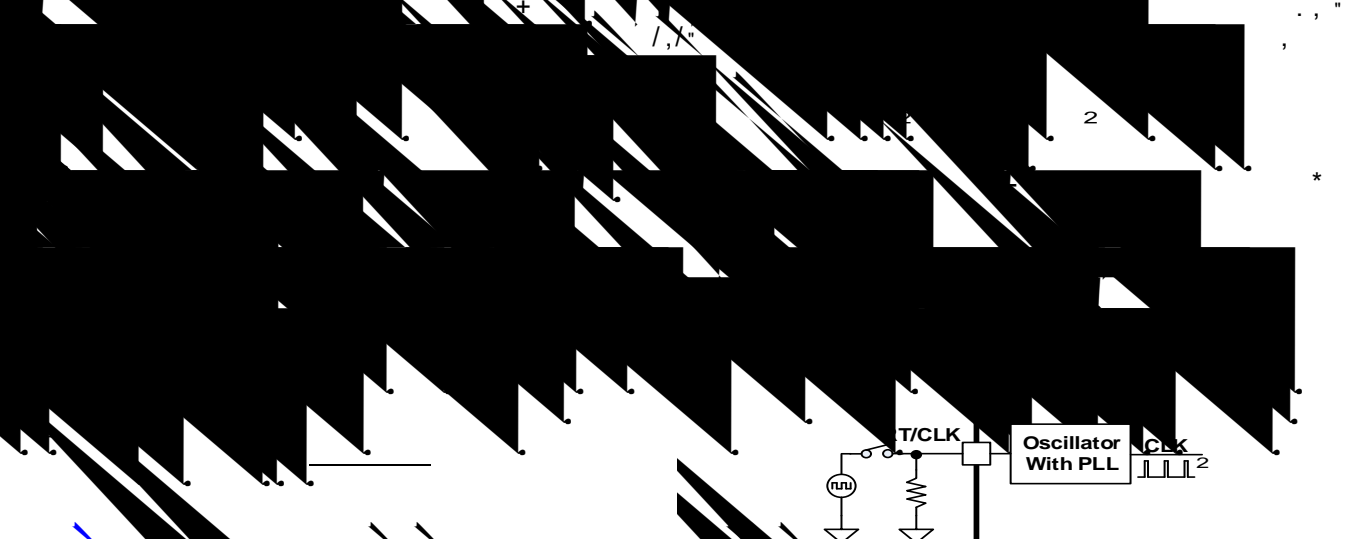
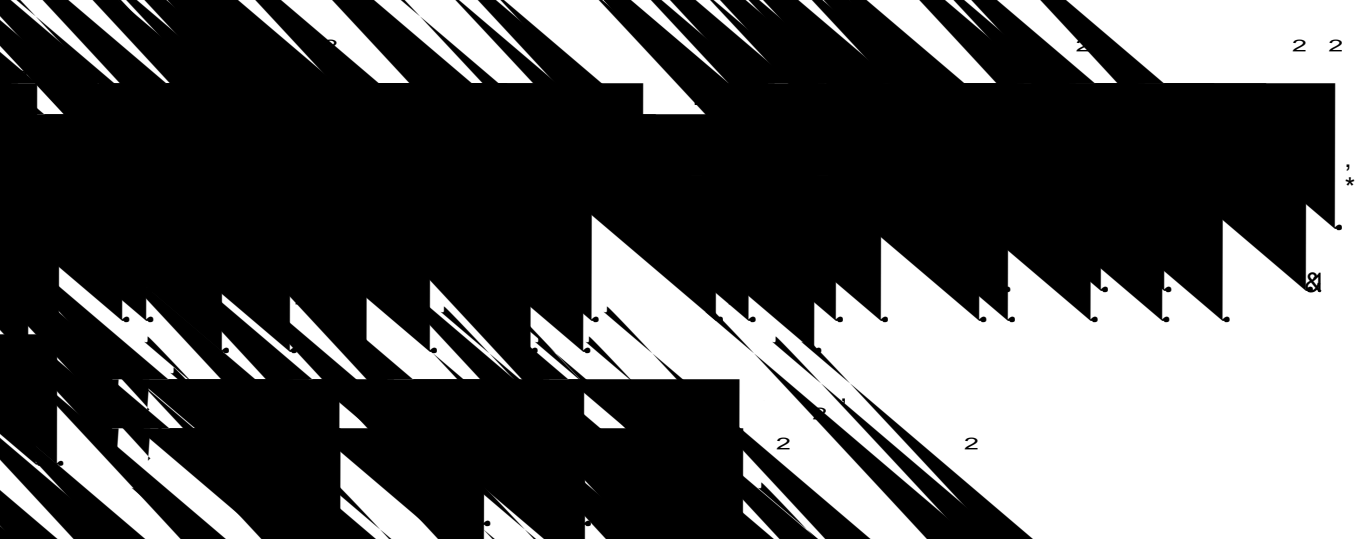
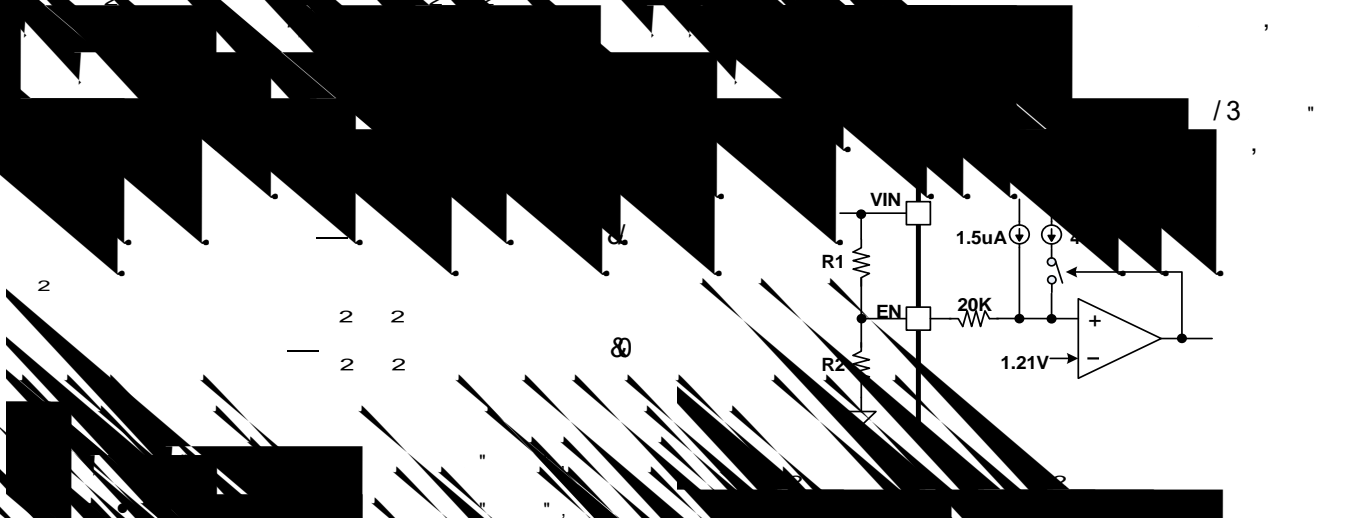



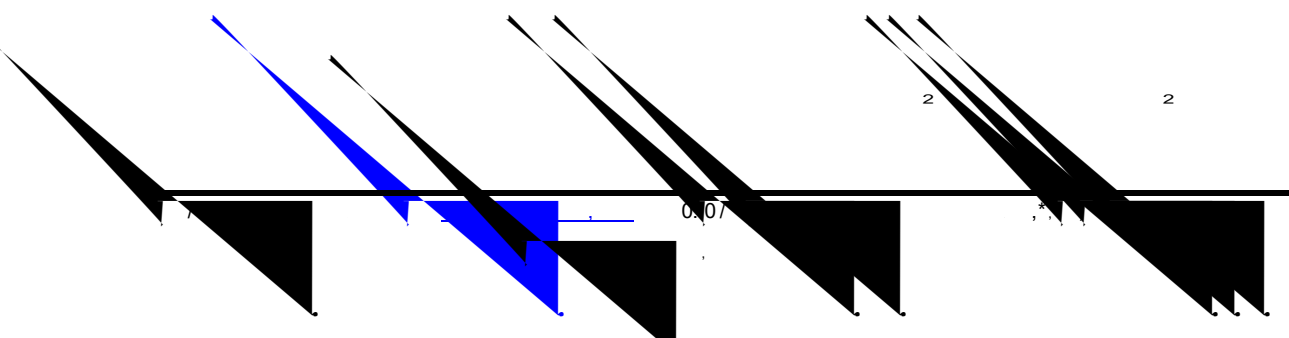
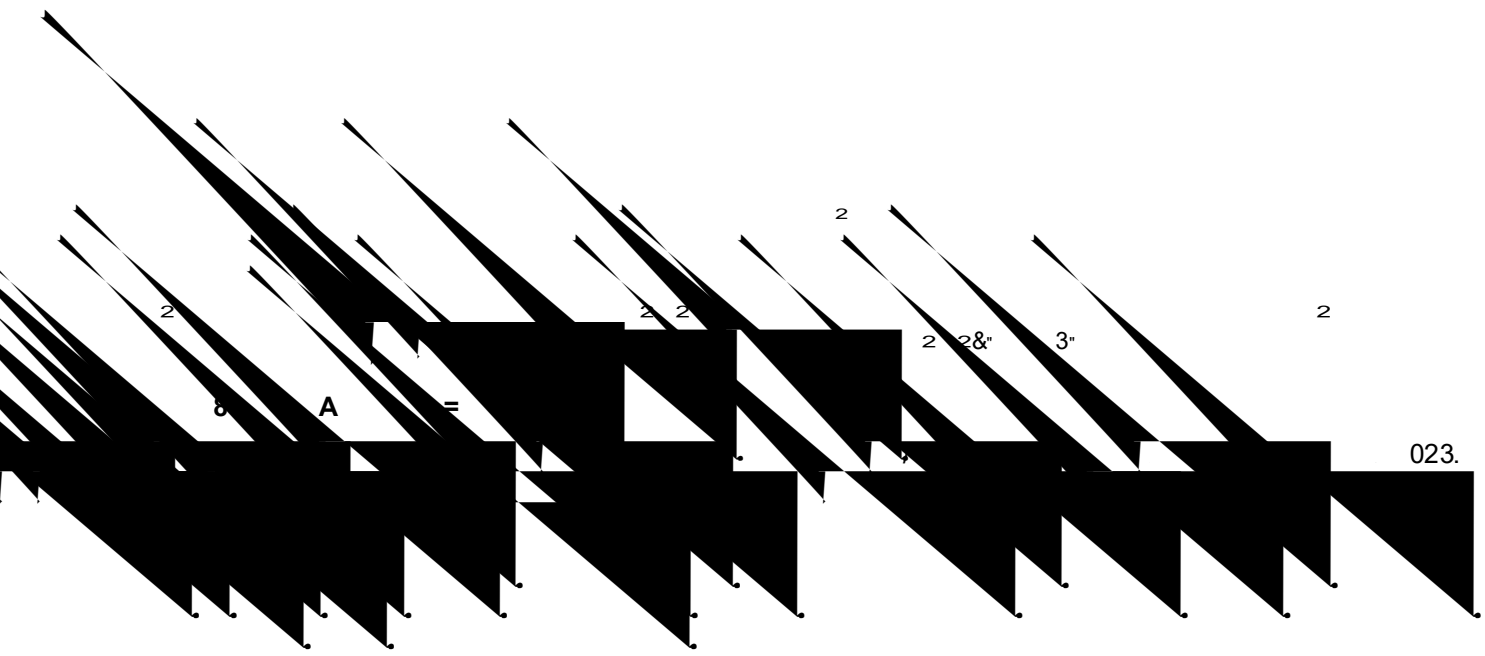

ETTPMEXMS RDR SV EXMS RD

6

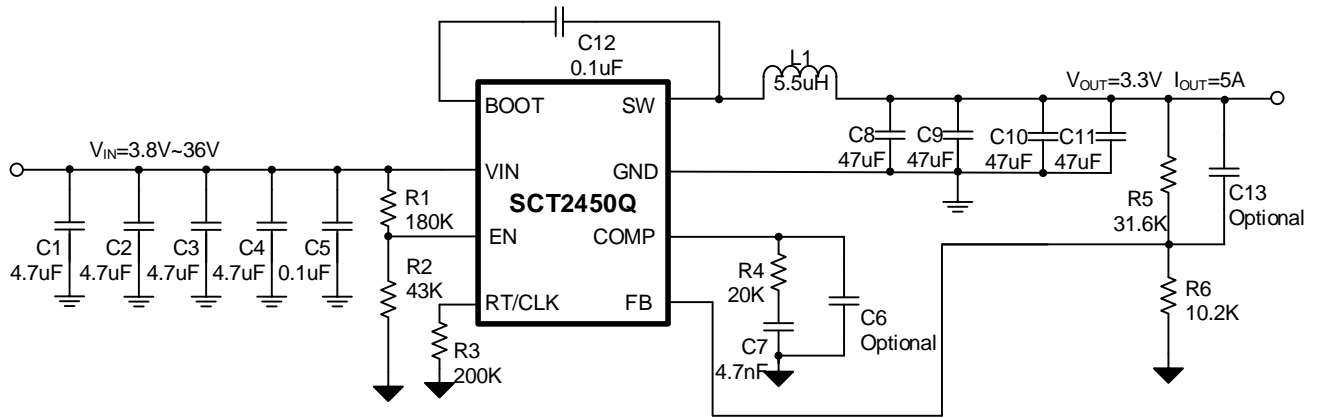

- 8) : ((6 A

	:
	02" 1, " 14"
	1,1"
	3
	3..
	/4,3 "
	" /13 "
& "	3, 4

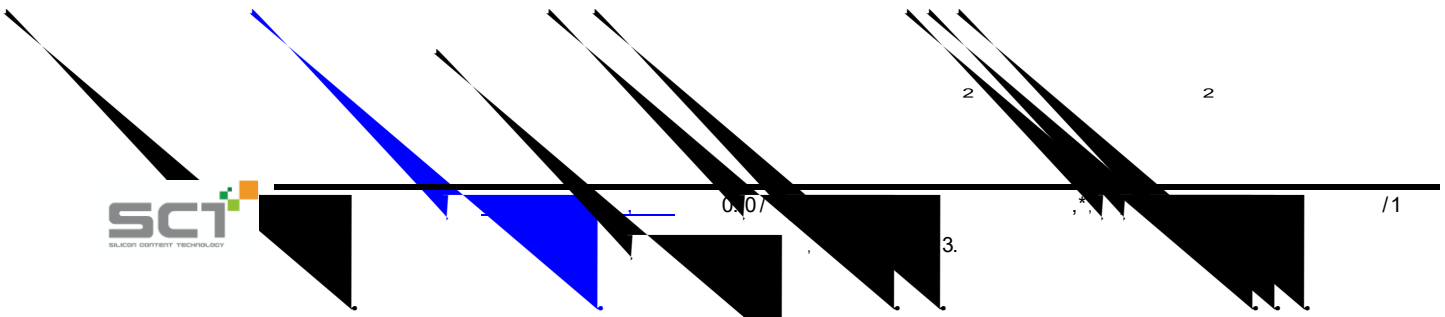

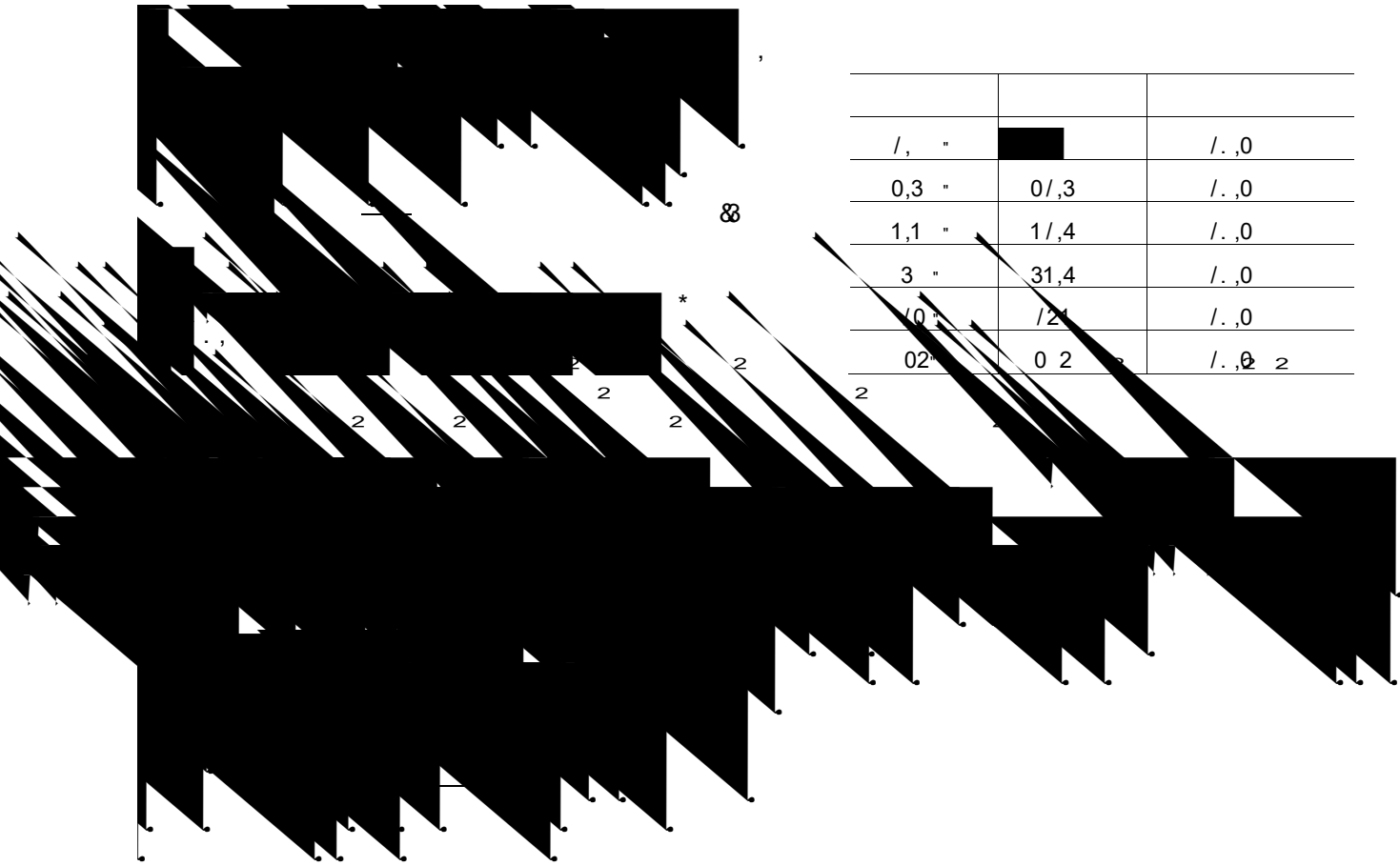

1, "		1,0
0,3 "	0,3	1,0
1,1 "	1,4	1,0
3 "	31,4	1,0
10 "	12	1,0
02 "	0,2	1,0 2

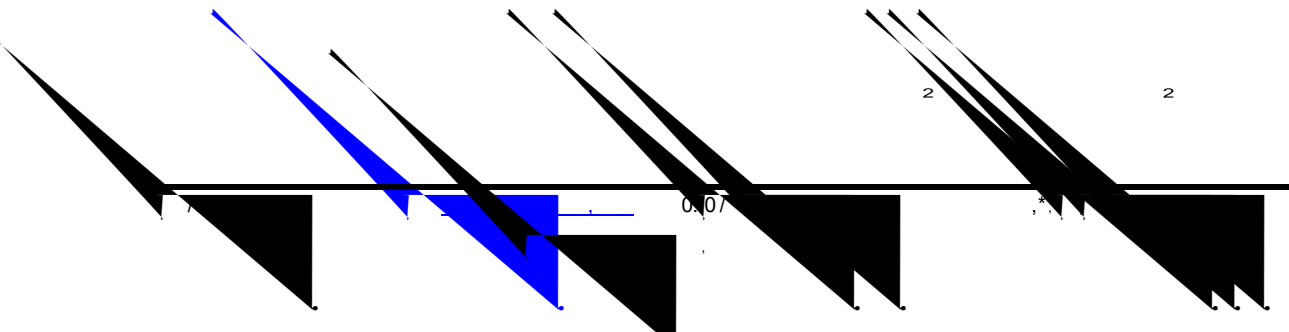

&

&.

&0

2 2

2 2

3,3

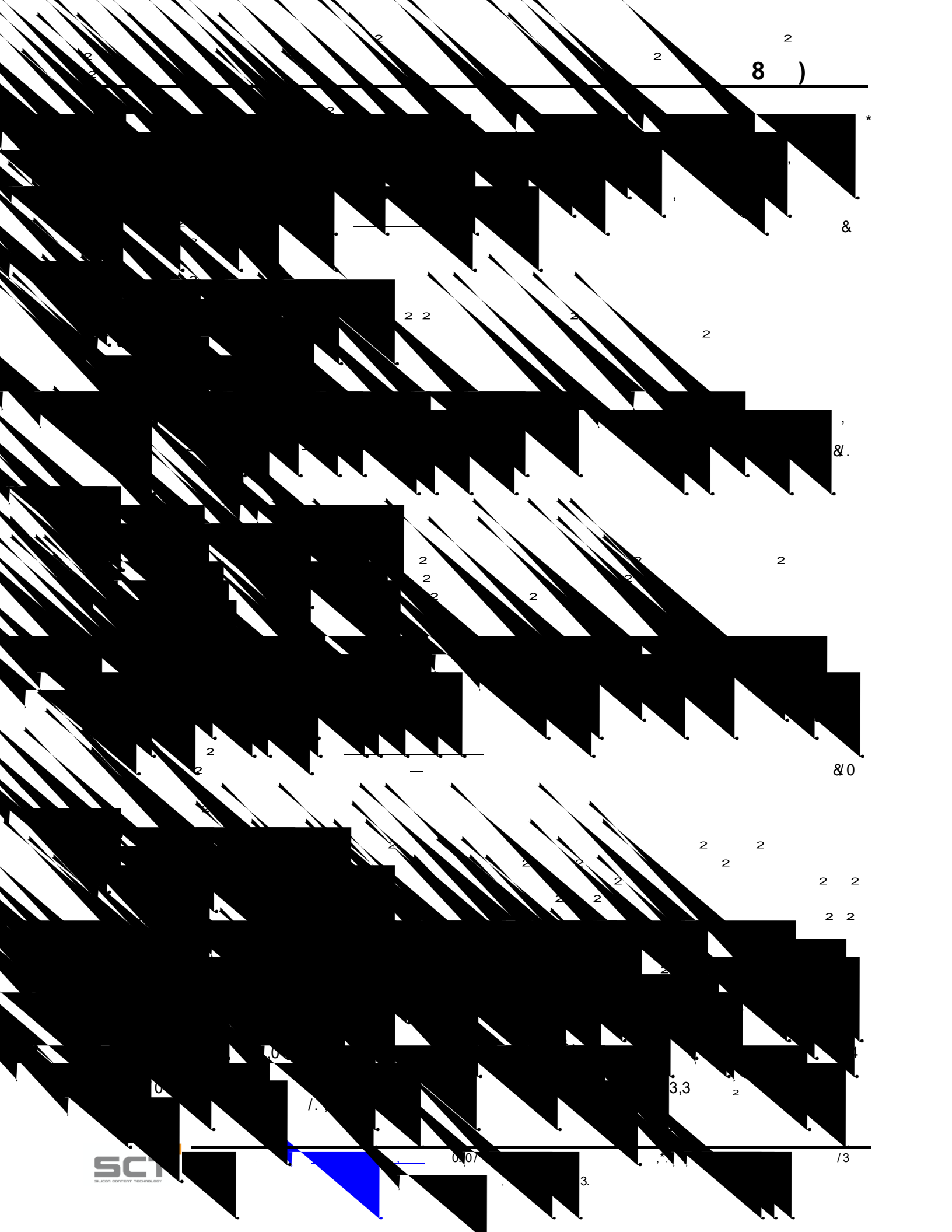



2 8

2

2

2

2

2

&1

2&2

2

3

./

2 2

2

2

2

2

&4

2

2

0.07

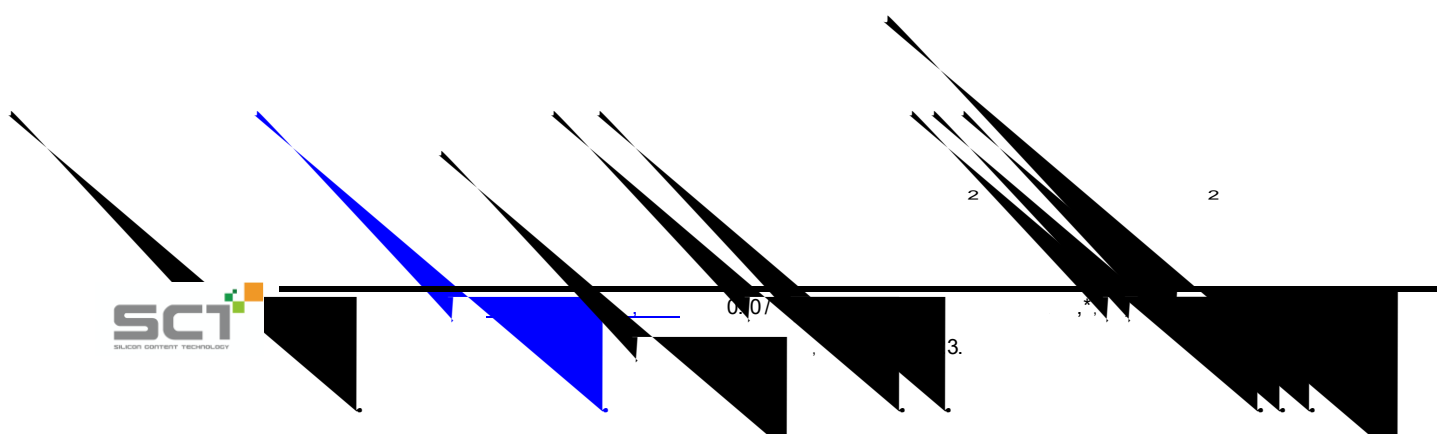

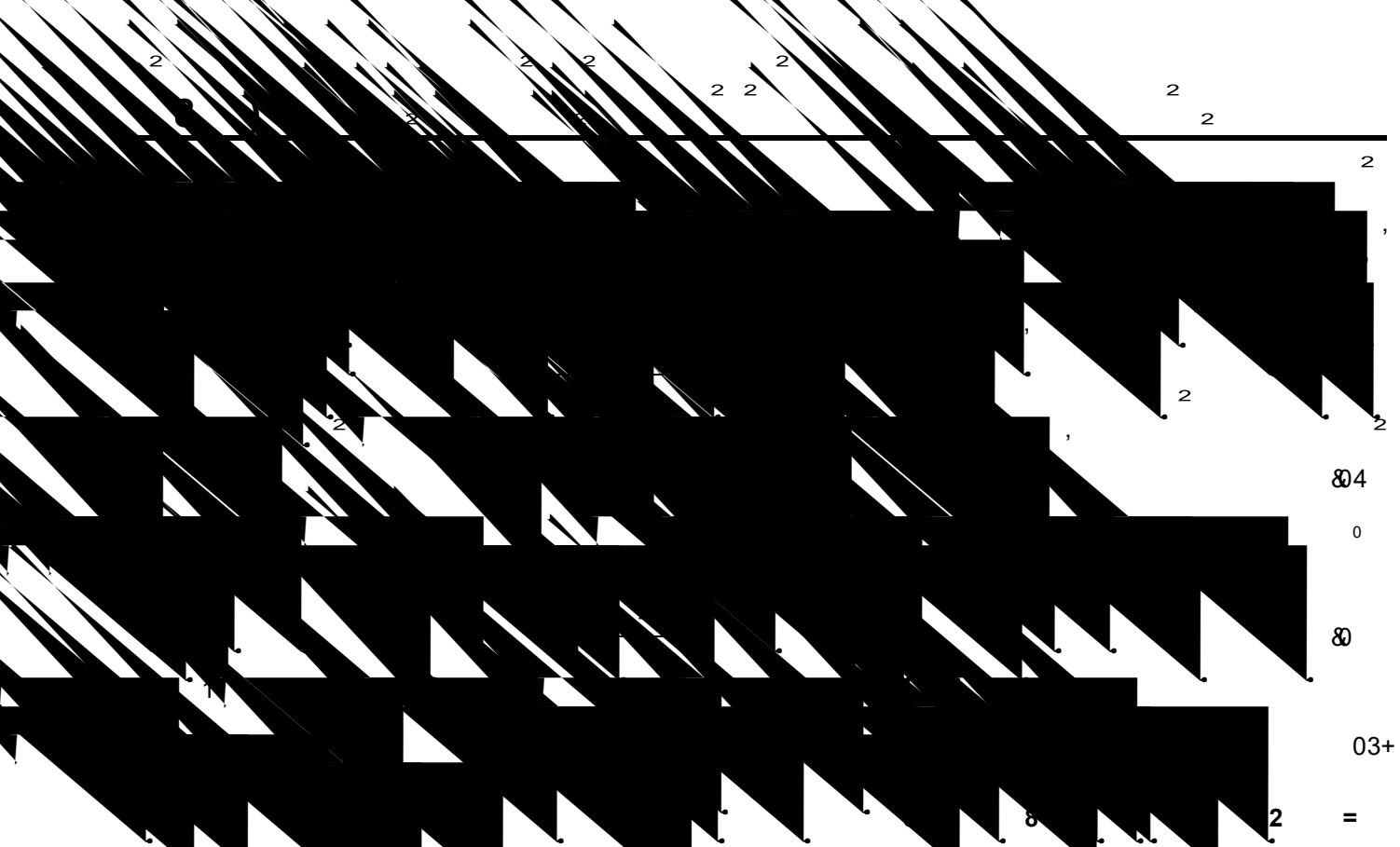

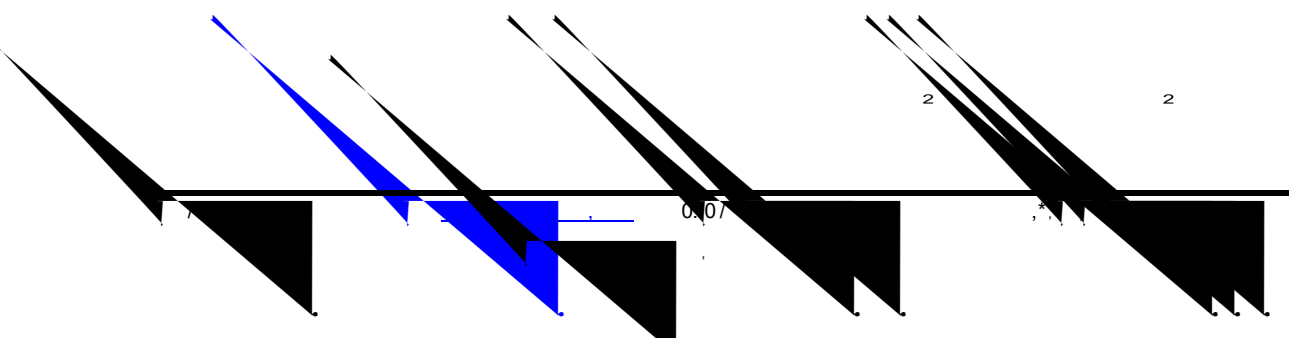

6

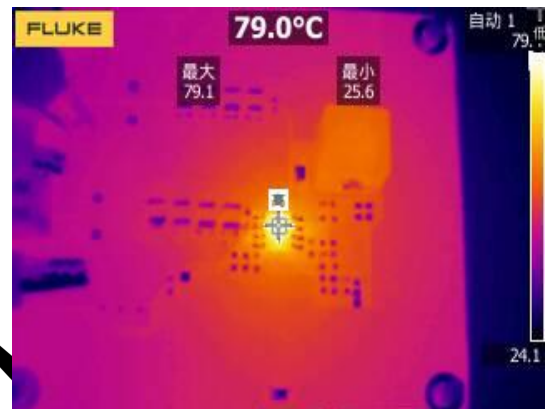
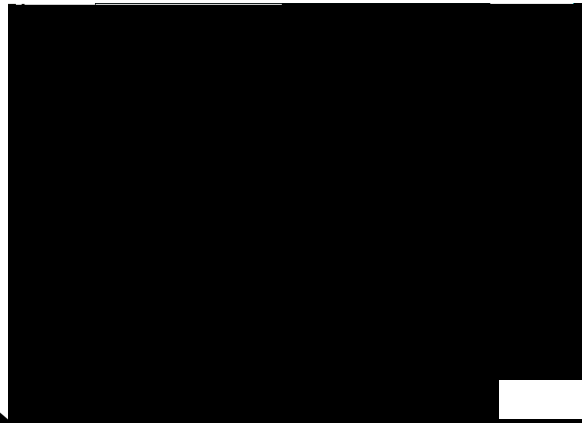
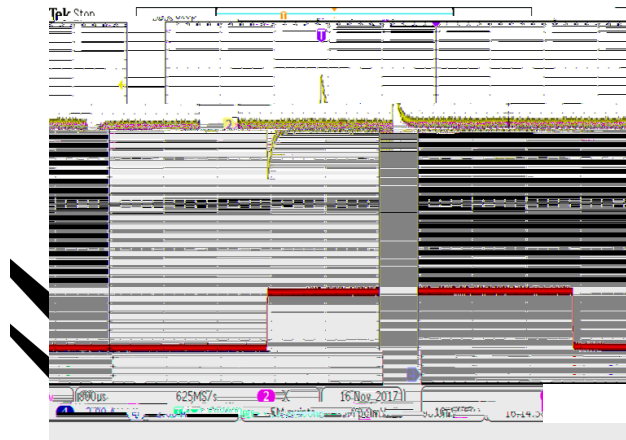
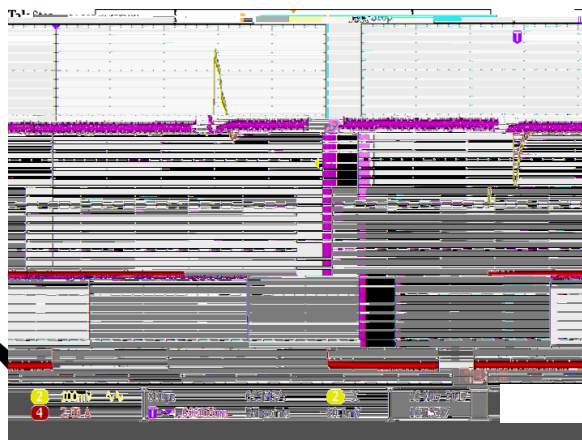
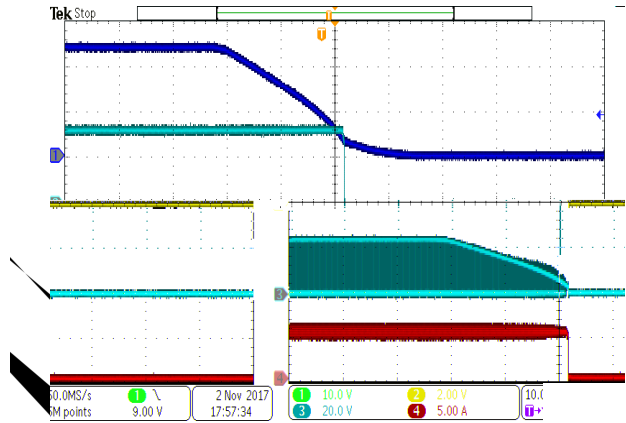
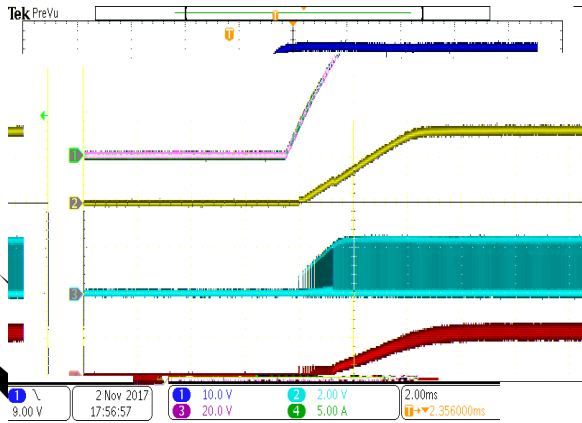

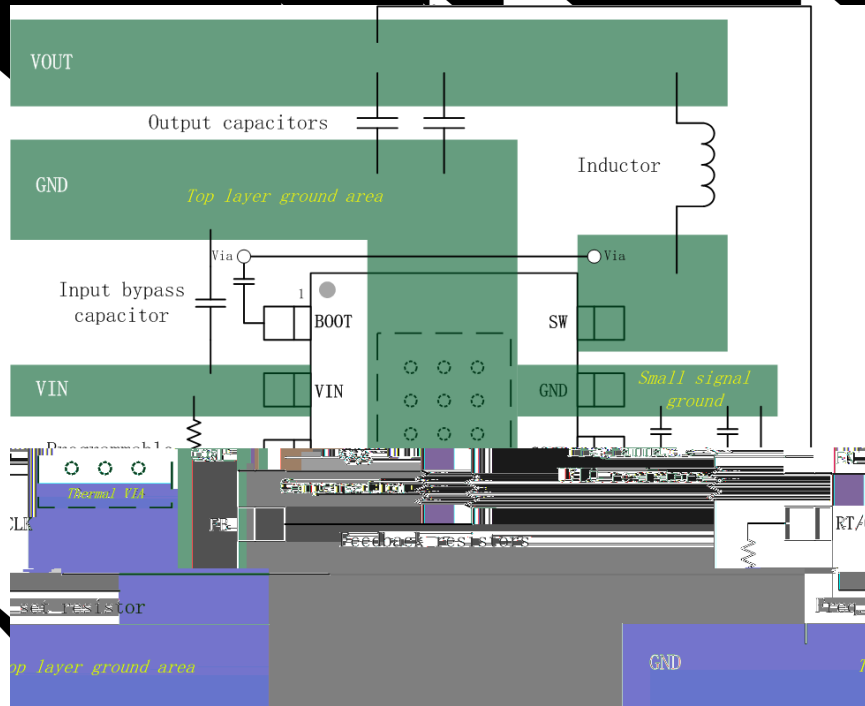

TEGOEKI DR SV EXMR

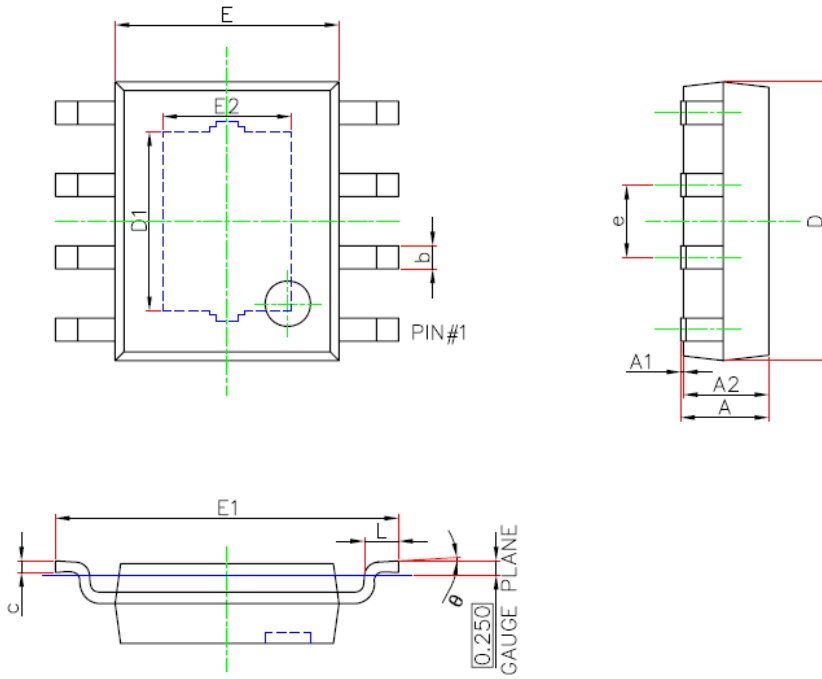

	/,1..		.. 3/	
/	..,, /..	..,, .. 2
0	/,13.	/,33.	.., 31	.., 4/
	..,11.	..,3/.	.., /1	.., 0.
		..,03.		.., /.
		3,/..	.., / 3	..,0. /
/	1, 3.	1,03.	.., /0.	.., /0
	1, ..	2,, /3.	
/	3, ..	4,0. .	.., 00	.., 022
0	0, /4.	0,14.	.., 3	.., 1
			.., 3. &	
θ	.., 2.		.., /4	.., 3.

XETI ERHIVI I PDR SV EXMRD

