HH

E d geEf ' i

h df d

FGD E

E D BF A

BB F A E

D H E A E F A D K

H A D D A D F A

1)		

E A G F G D F E

- (1)
- (2)

B A G D F A

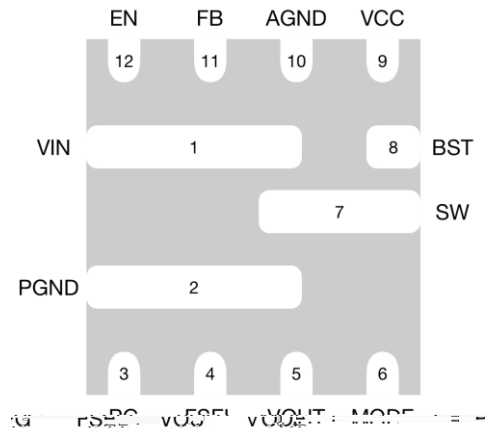

B G F A E

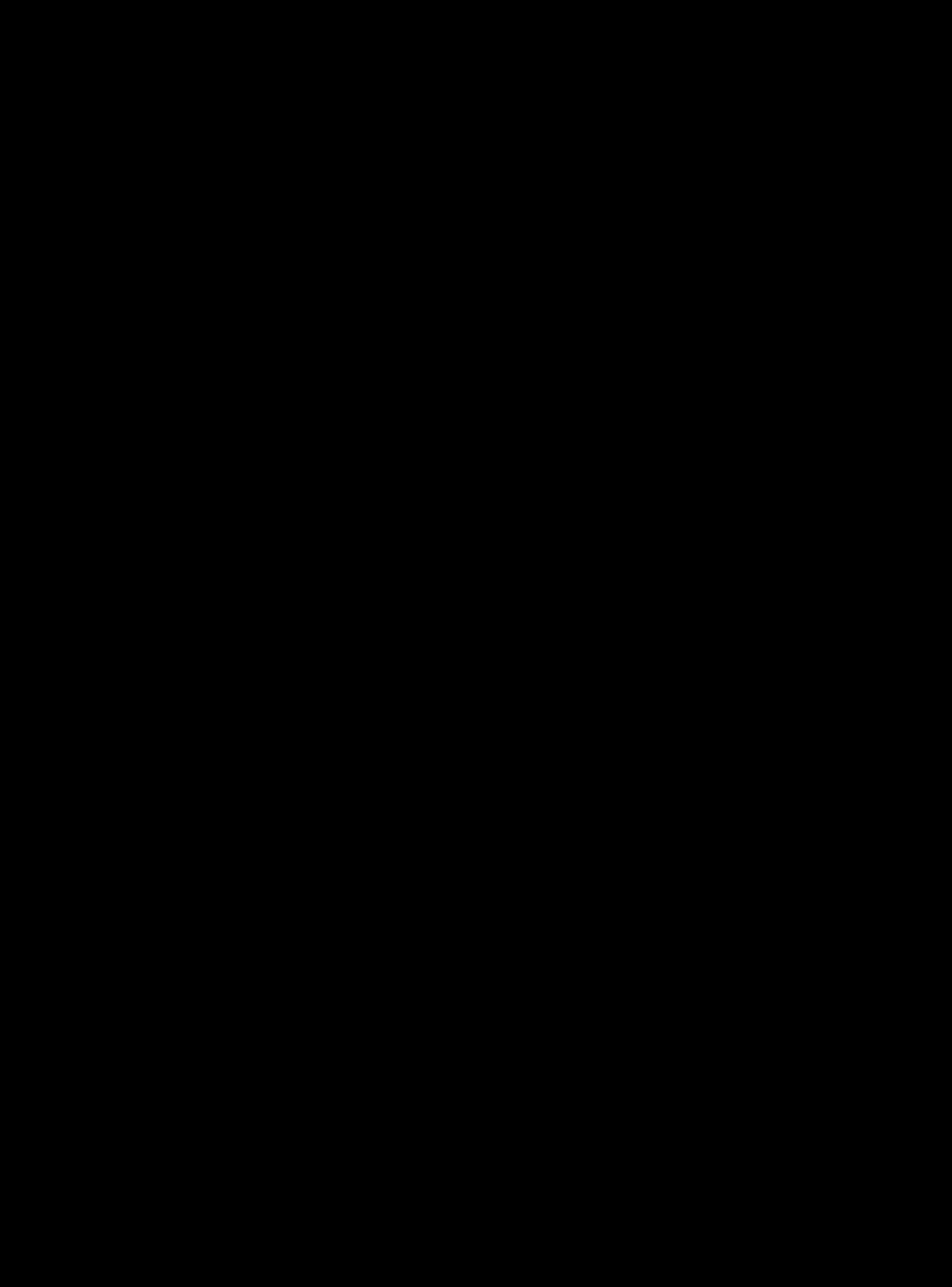

FKB

D F D E F E

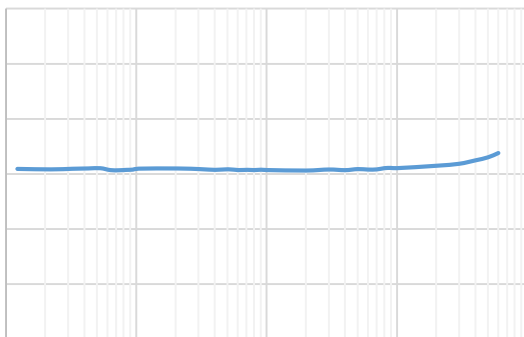
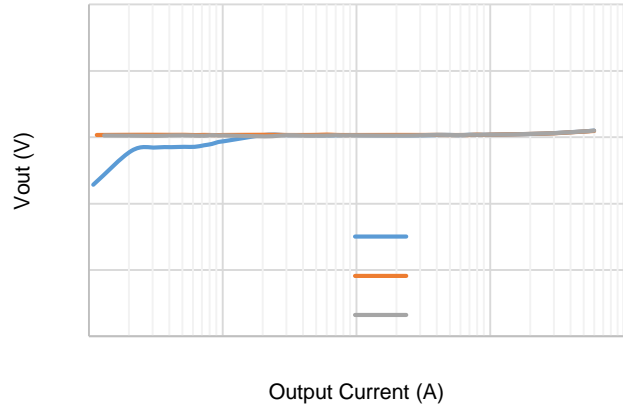
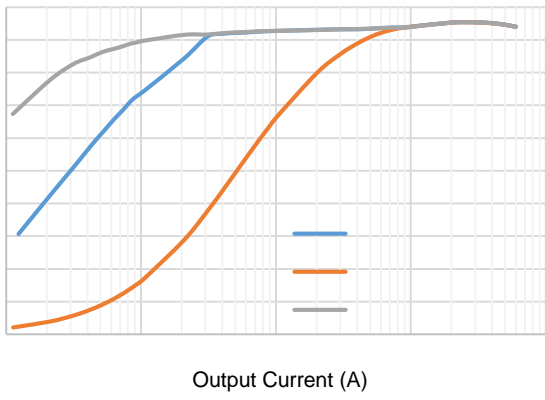
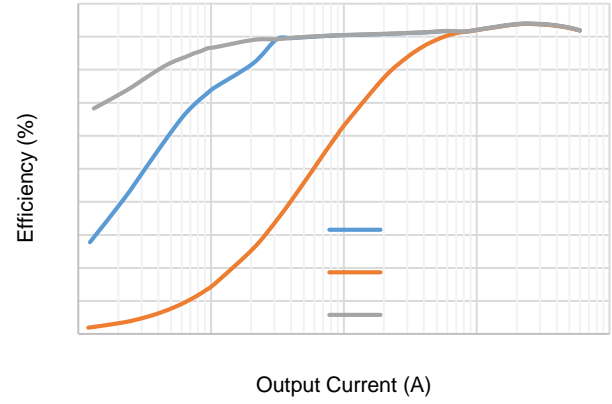
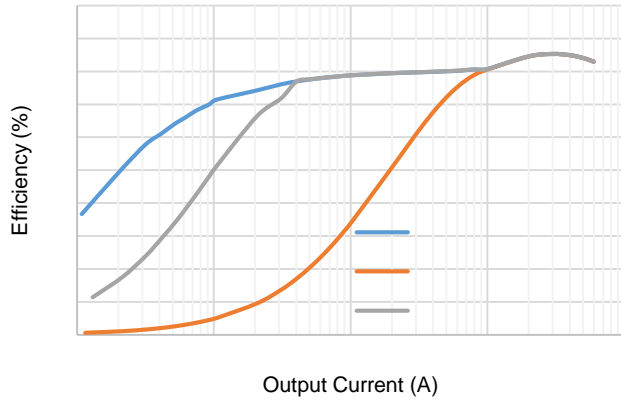

AB D F A

$$V_{\text{rise}} = 1.18 * \left(1 + \frac{R1}{R2}\right) - 1.5\mu\text{A} * R1$$

$$V_{\text{fall}} = 1.1 * \left(1 + \frac{R1}{R2}\right) - 5.5\mu\text{A} * R1$$

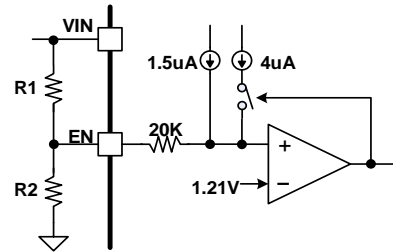

1% tolerance

$$R_{FB_TOP} = \left(\frac{V_{OUT}}{V_{REF}} - 1\right) * R_{FB_BOT}$$



v

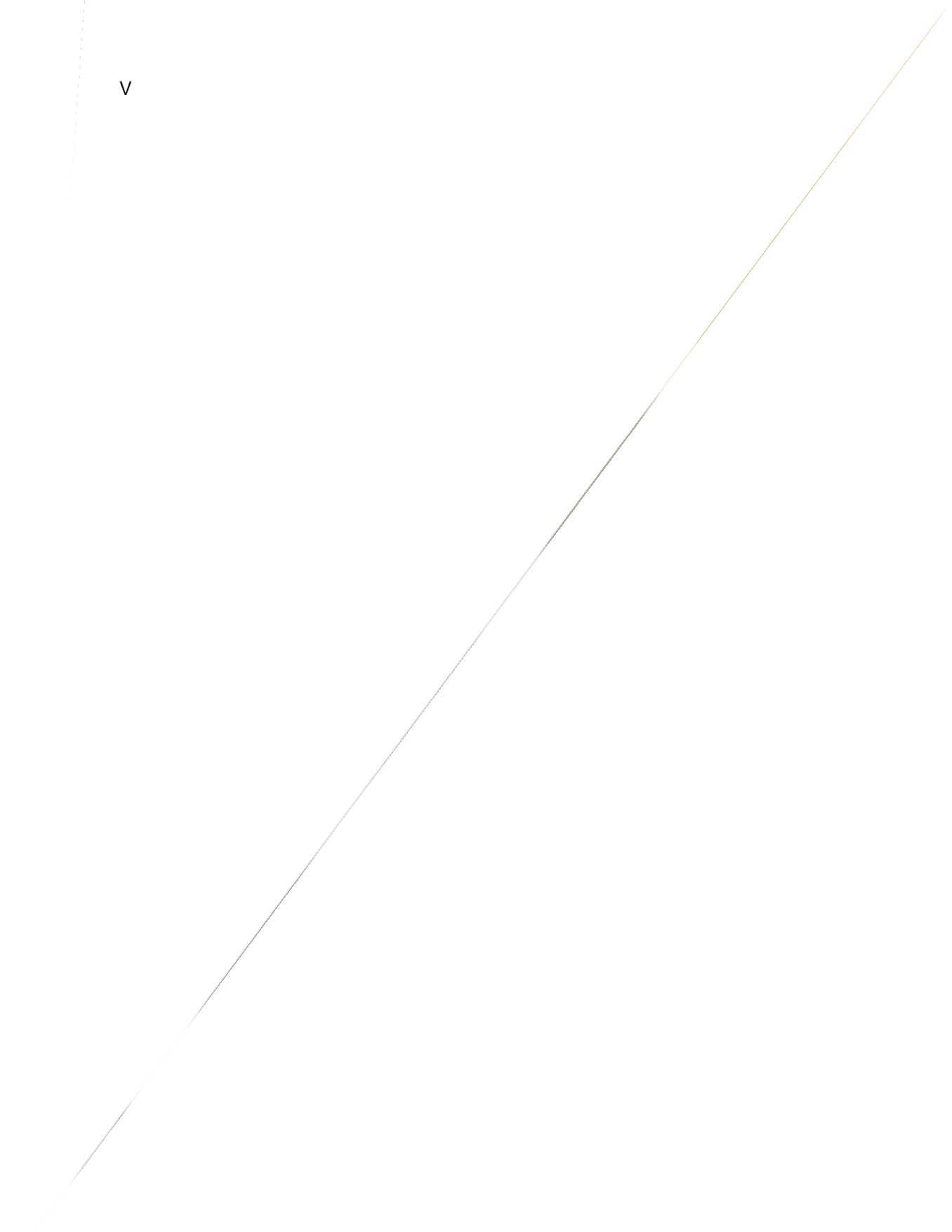

BB F A AD F A

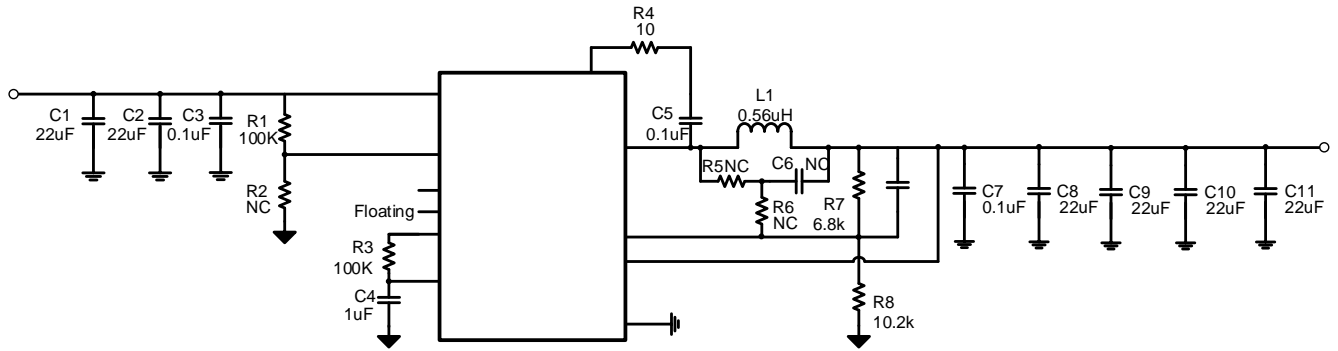

$$\Delta V_{IN} = \frac{I_{OUT}}{C_{IN} \times f_{SW}} \times \frac{V_{OUT}}{V_{IN}} \times \left(1 - \frac{V_{OUT}}{V_{IN}}\right)$$

$$L_{INDMIN} = \frac{V_{OUT} \times (V_{INMAX} - V_{OUT})}{V_{INMAX} \times K_{IND} \times I_{OUT} \times f_{SW}}$$

$$I_{LPEAK} = I_{OUT} + K_{IND}$$

$$\Delta V_{OUT} = \frac{V_{OUT} * (V_{IN} - V_{OUT})}{8 * f_{SW}^2 * L * C_{OUT} * V_{IN}}$$

V_{OUT}

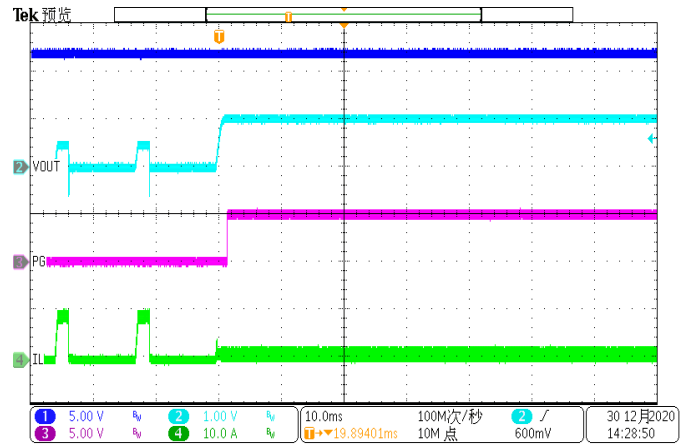
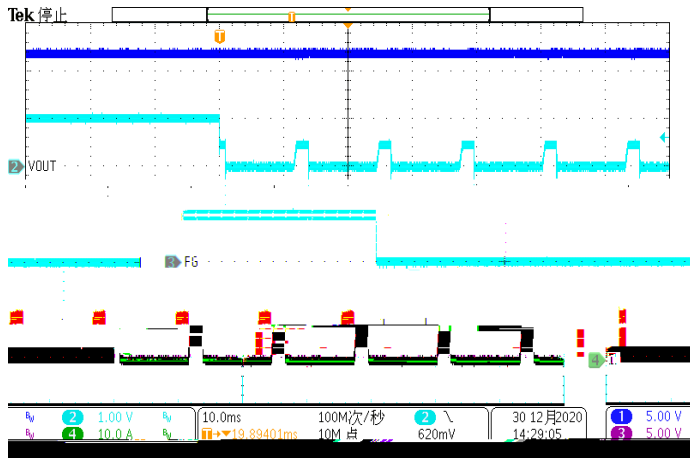
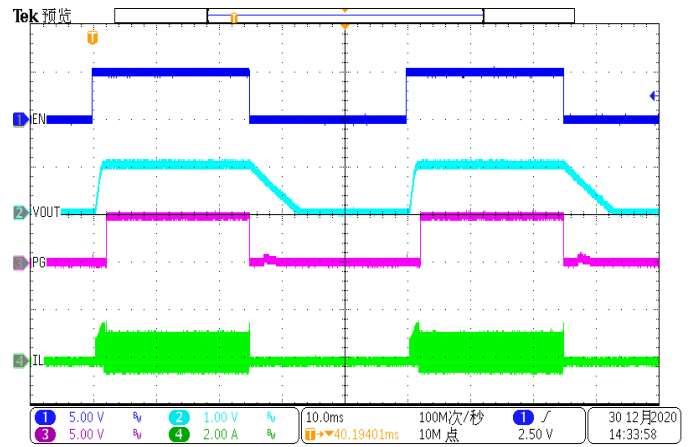
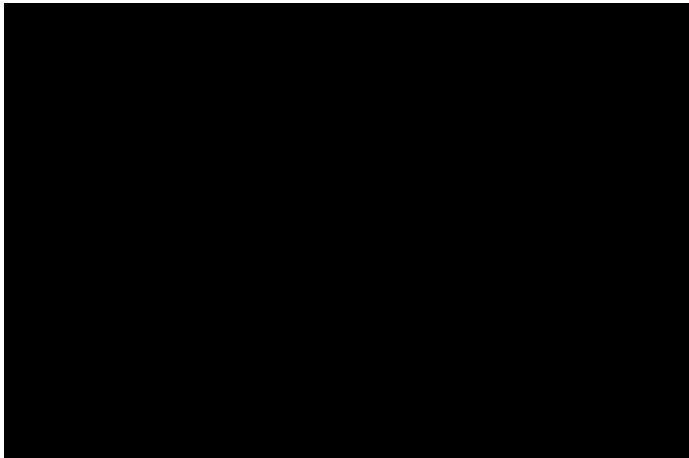
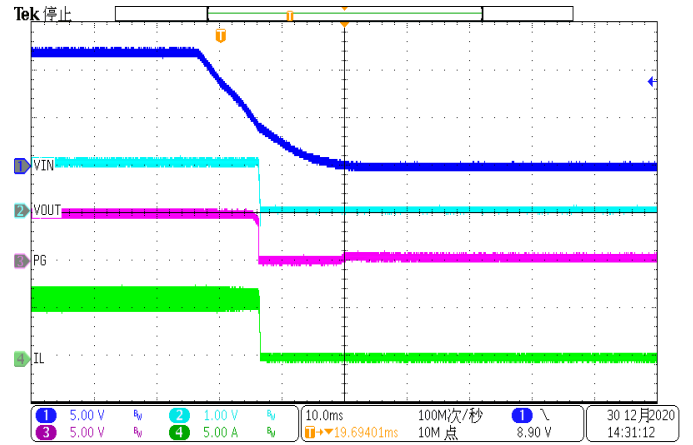
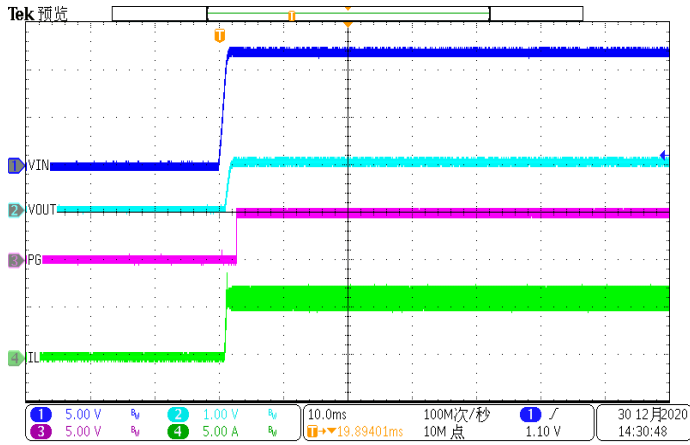

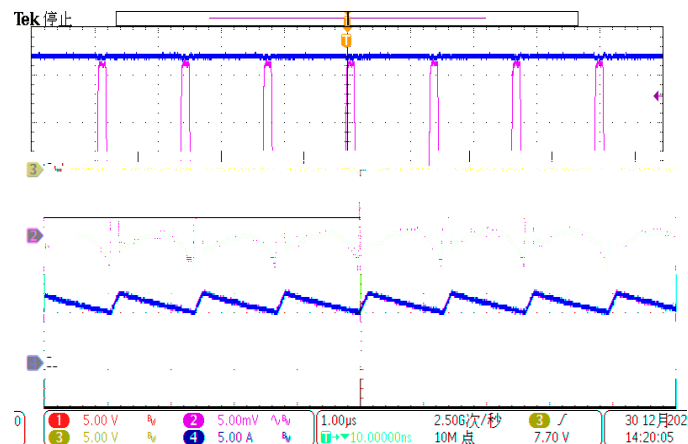
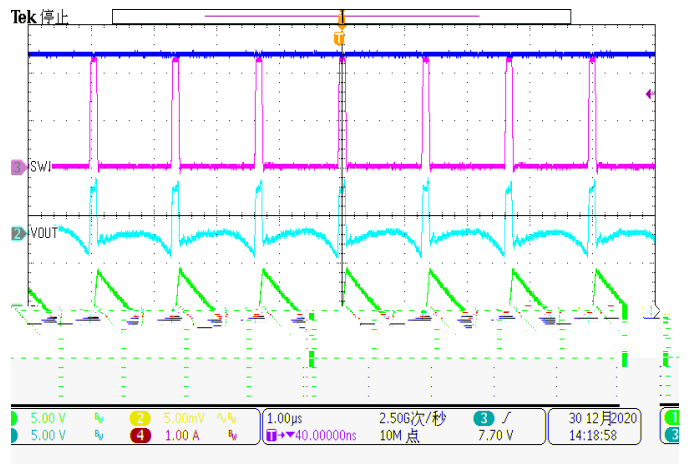
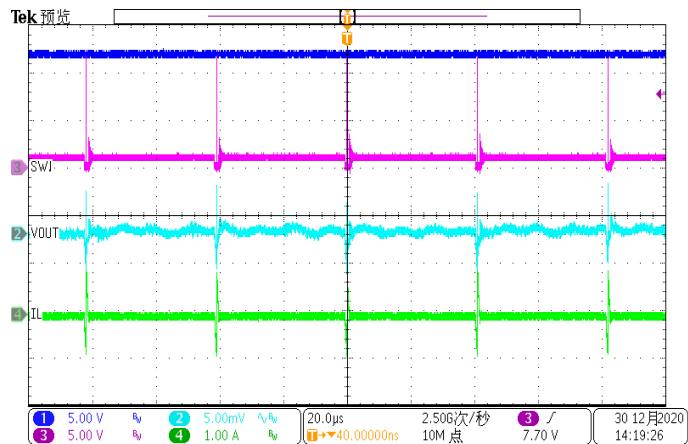
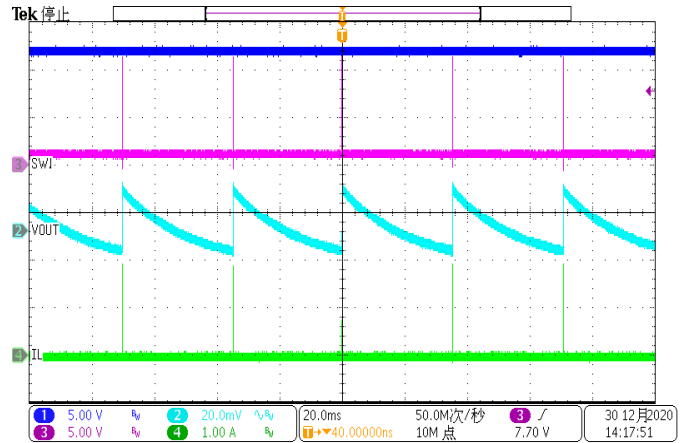
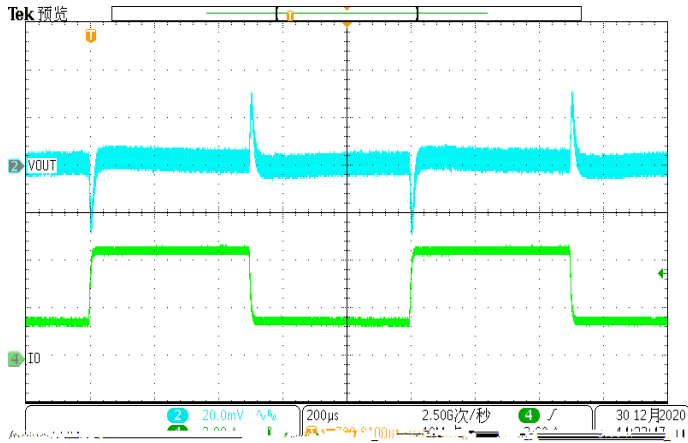

-
- 1.
 - 2.
 - 3.
 - 4.
 - 5.
 - 6.

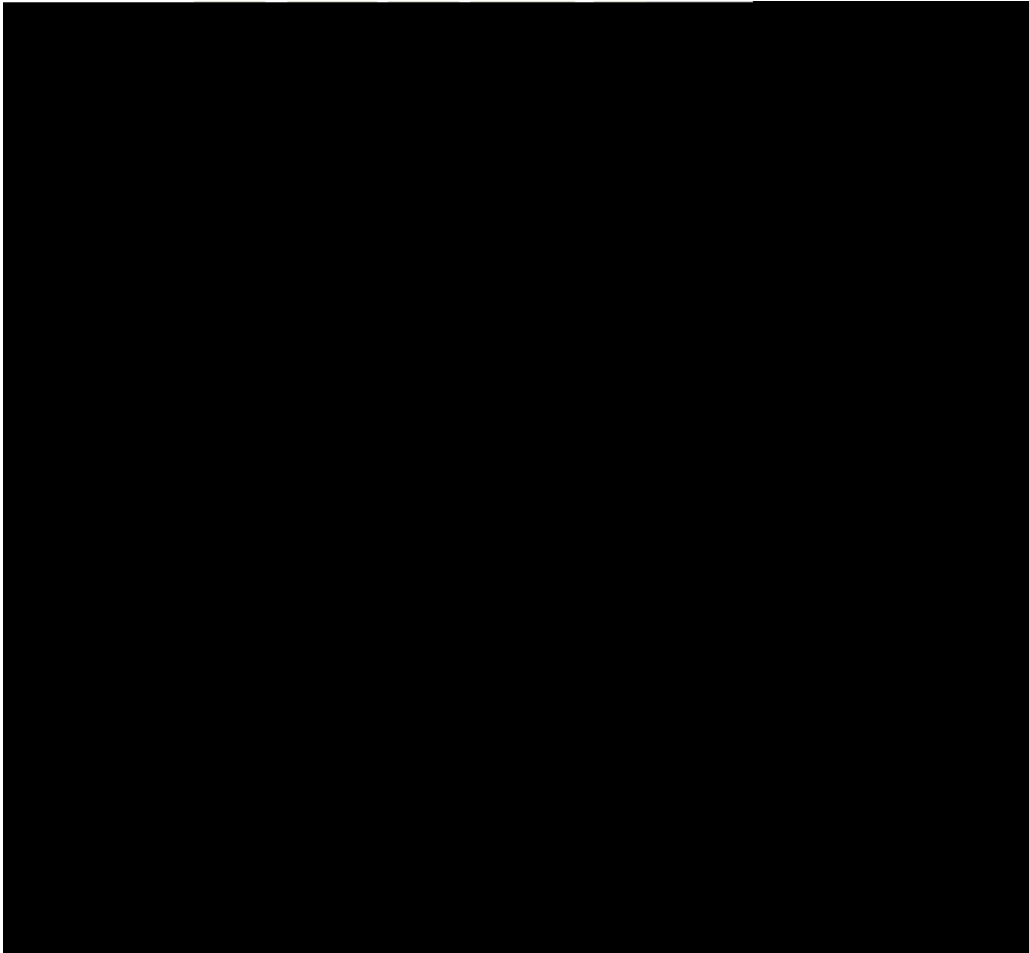

B  **AD F A**

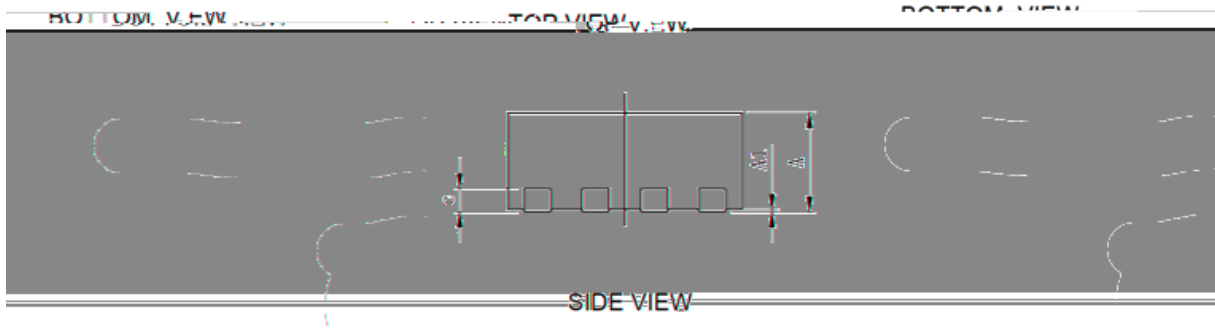
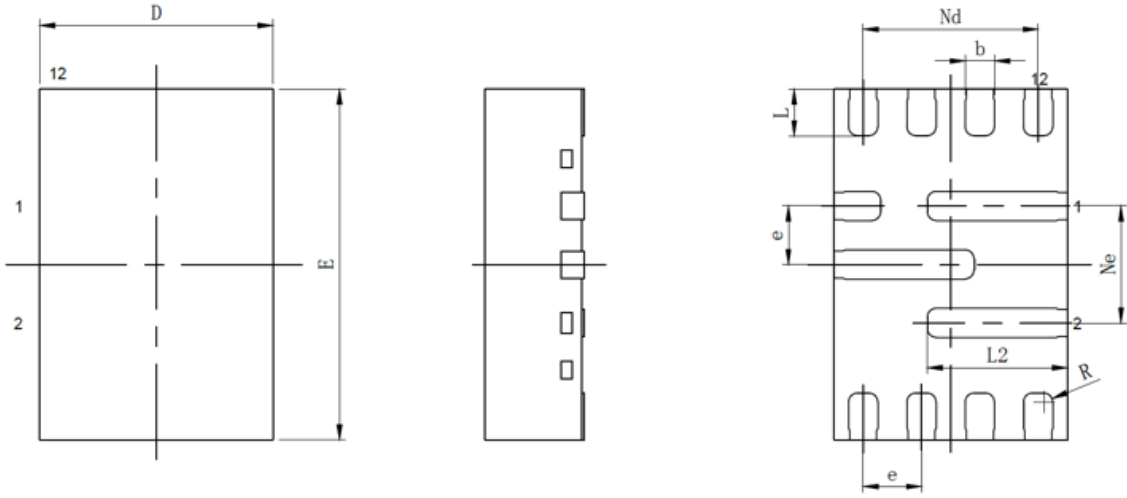

- 1.
- 2.
- 3.
- 4.
- 5.

F B D AD F A

