3V-40V V_{in} , 150mA, 2.5 μ A I_Q , Low-Dropout Regulator

GFB F

EF D POA

±

±

B MDB PO A

F POA P A

Revision 1.0: Release to production.

Revision 1.1: Update the thermal information and the thermal characteristic.

Revision 1.2: Update the thermal information and the thermal characteristic.

Revision 1.3: Update the TAPE AND REEL INFORMATION.

EF DFP EF AOGP NB POA

ODPOG H B POA

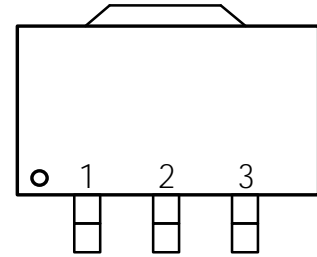
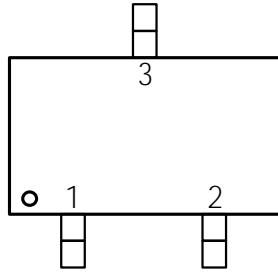
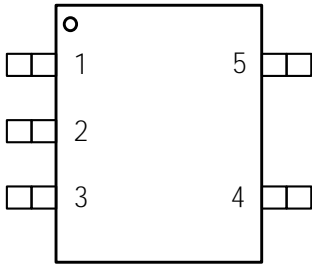

A

OG OD PO A

P D GXX A

P D GXX A

P D GXX A

A

A

A

FDPNNFOEFEP F B OHADPOE PO A

--	--	--	--	--

DBM DI B BD F D A

DBM DI B BD F D A A

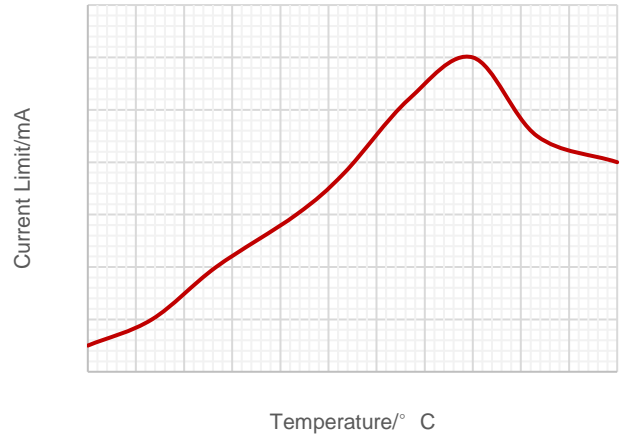
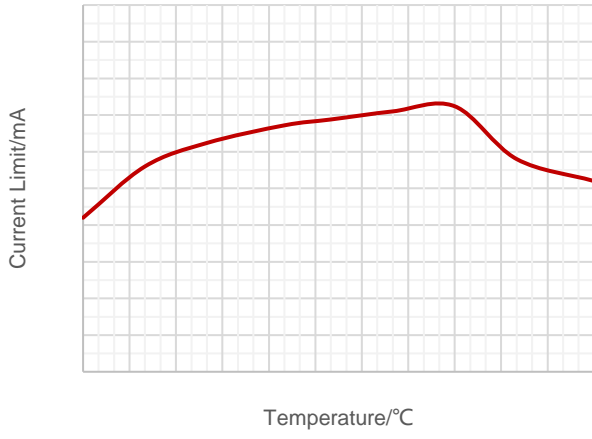
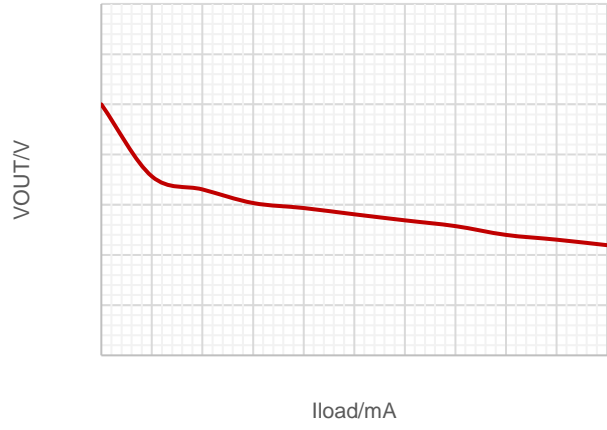
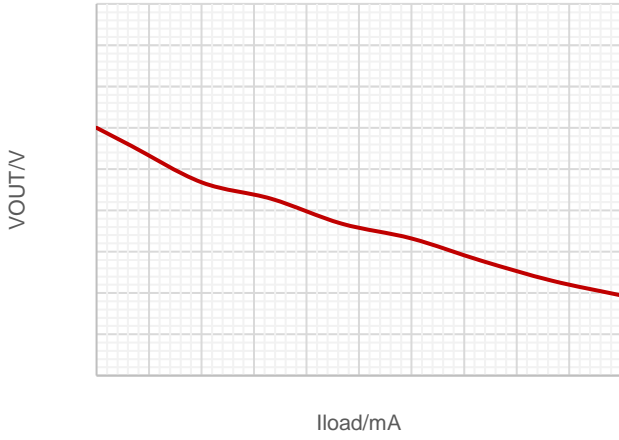

A
A

A

DBM DI B BD F DA A

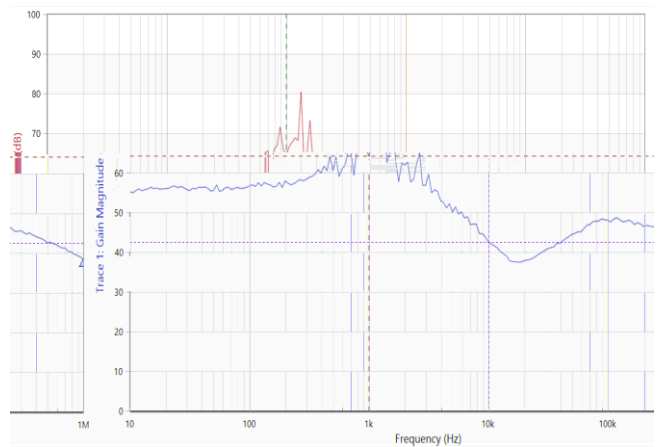
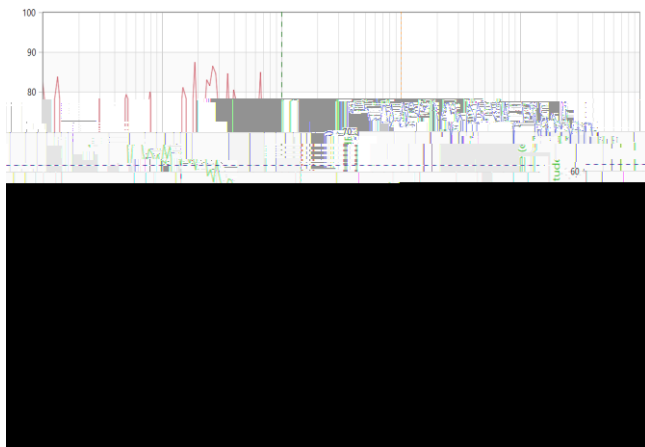
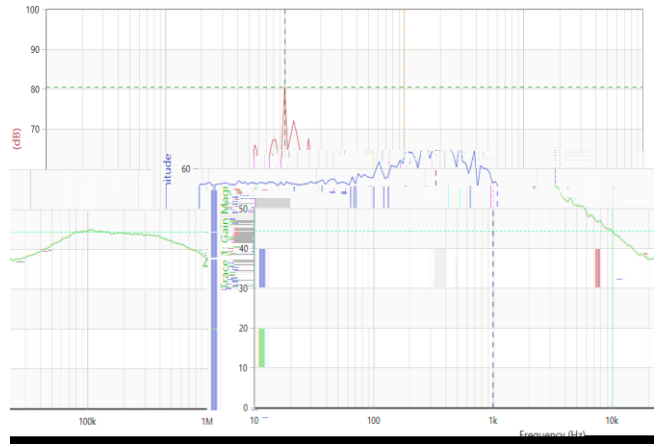
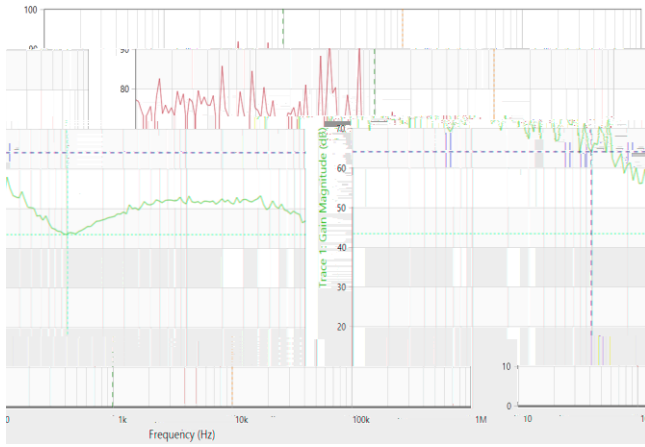
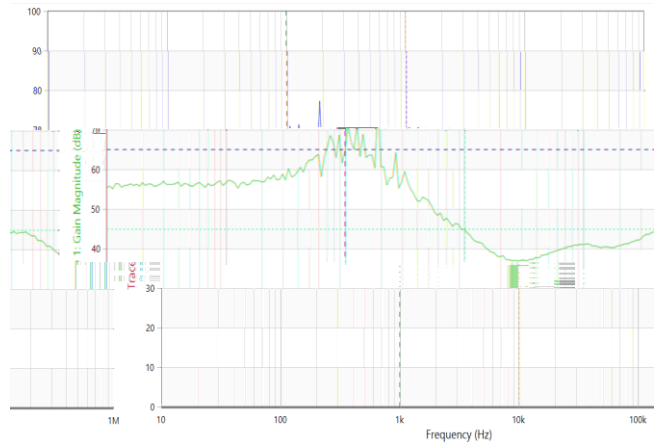
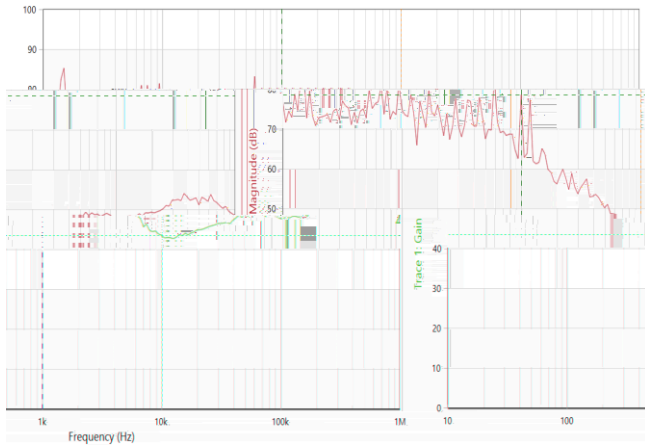

A

G OD POBMCMPDLÆ BH BNA

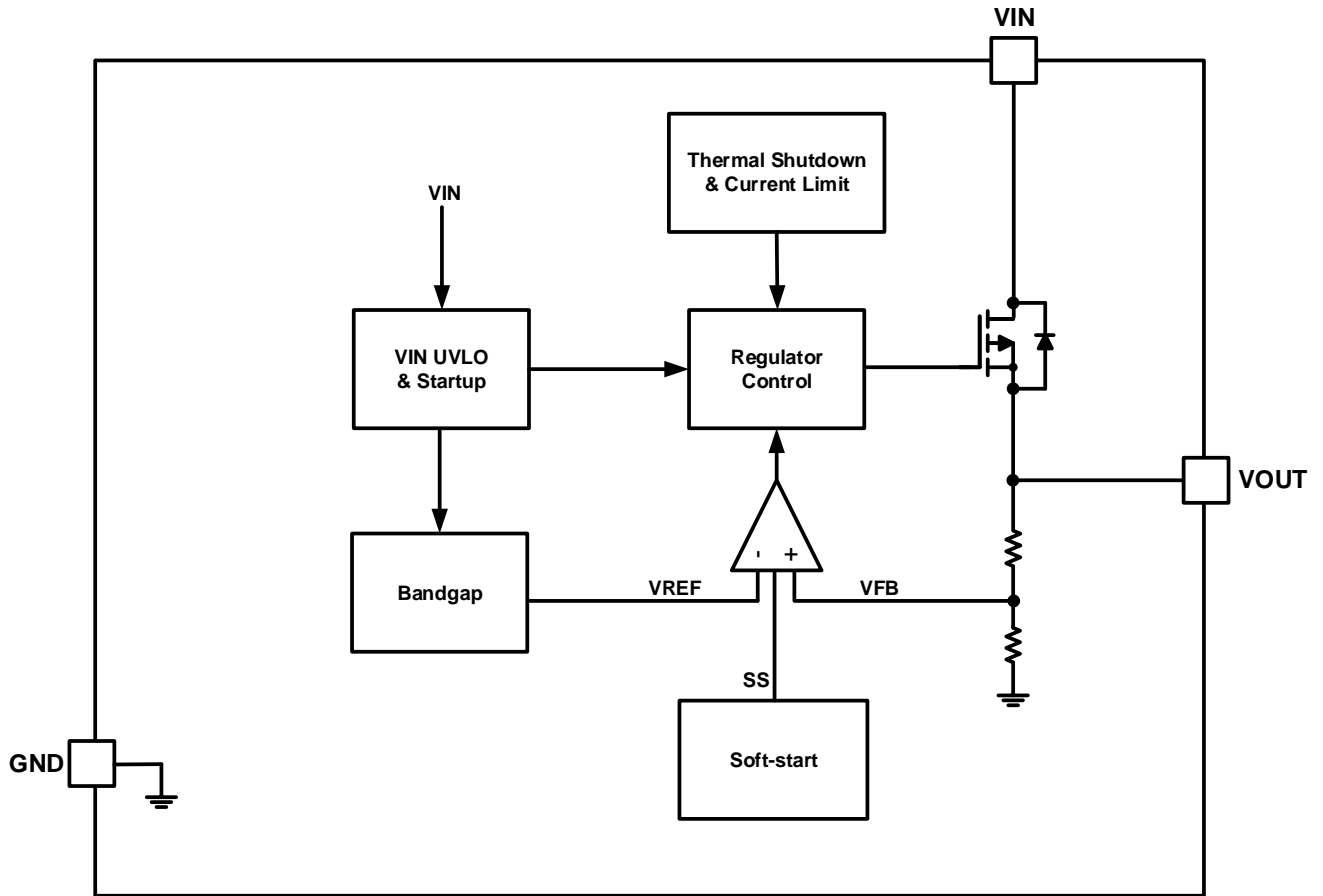

P F B POA

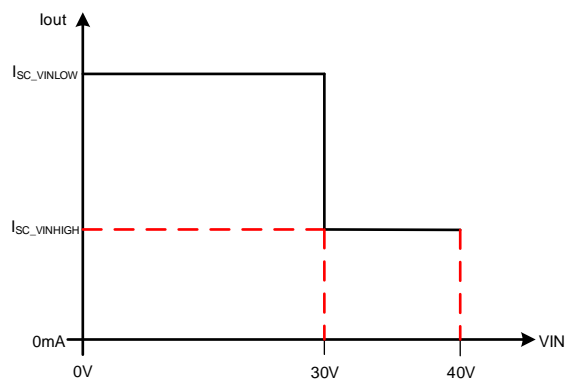

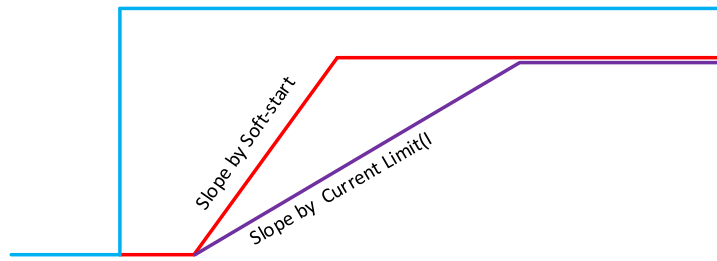

B MDB POAGP NB POA

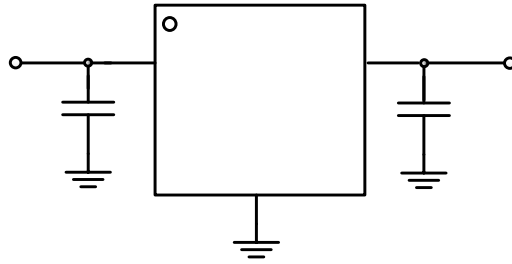

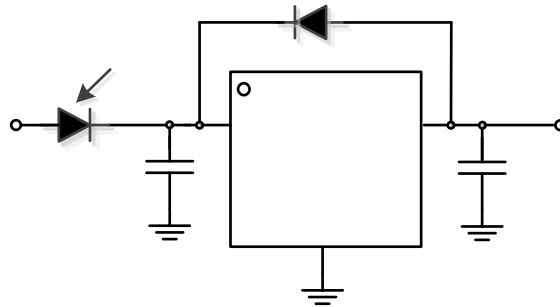

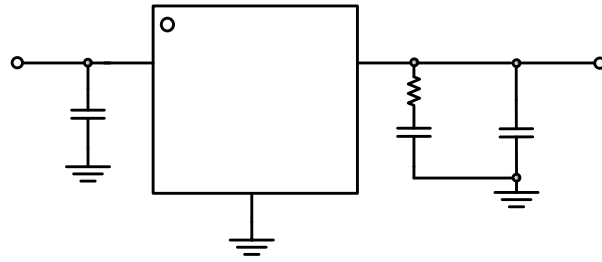

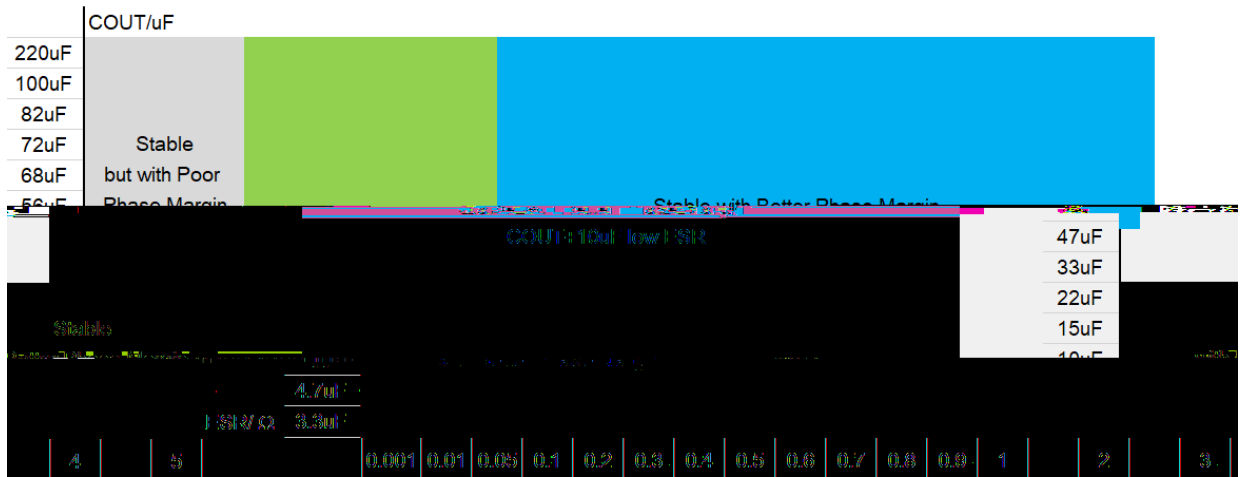



			°C



I F N B M D I B B D F D A

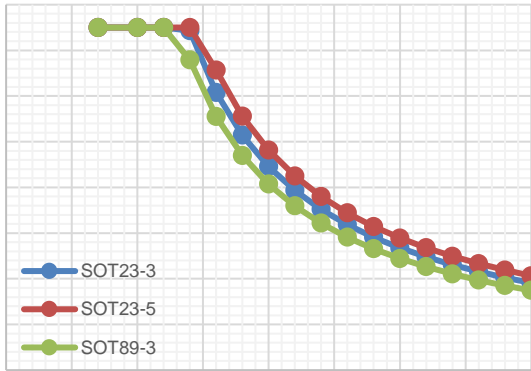

VIN/V

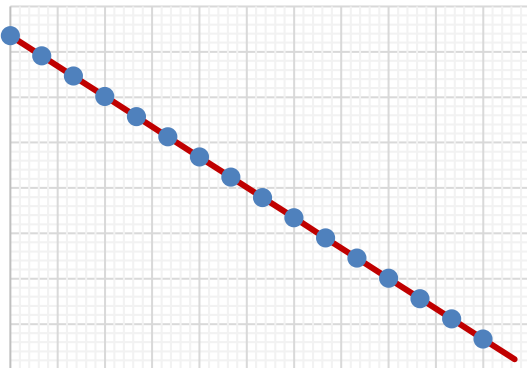
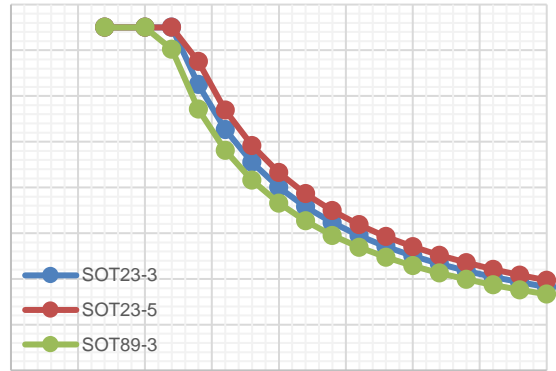

°C

°C

°C

°C

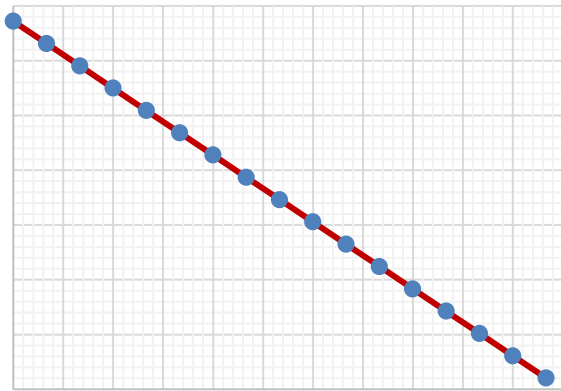

°C

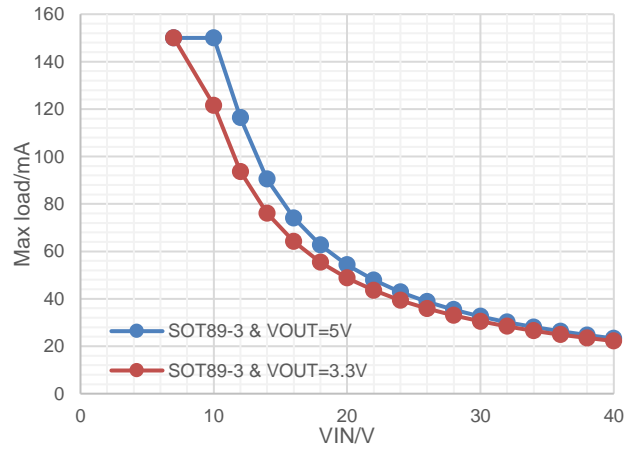

°C

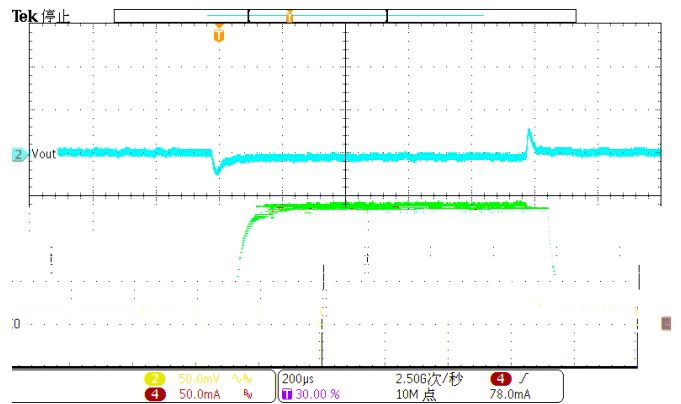
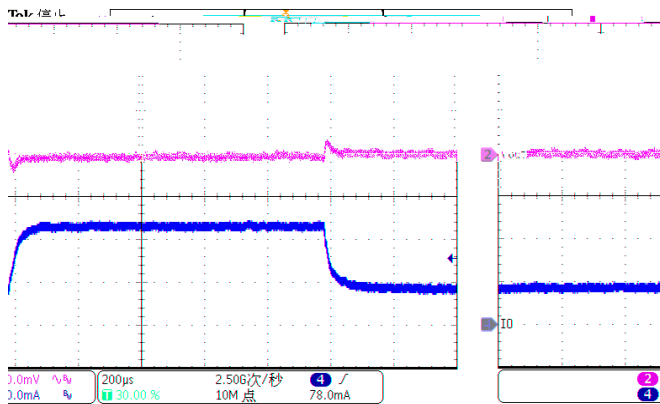
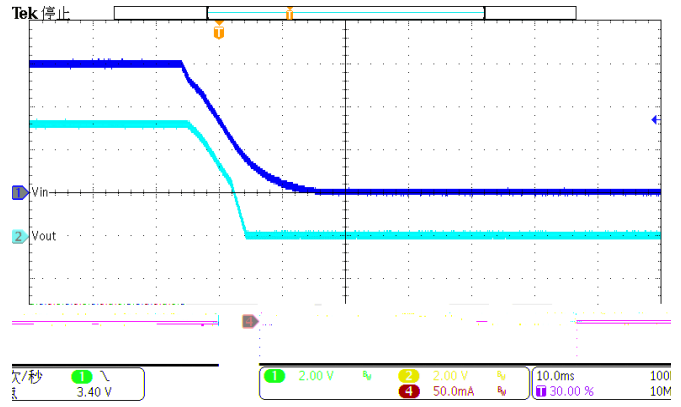
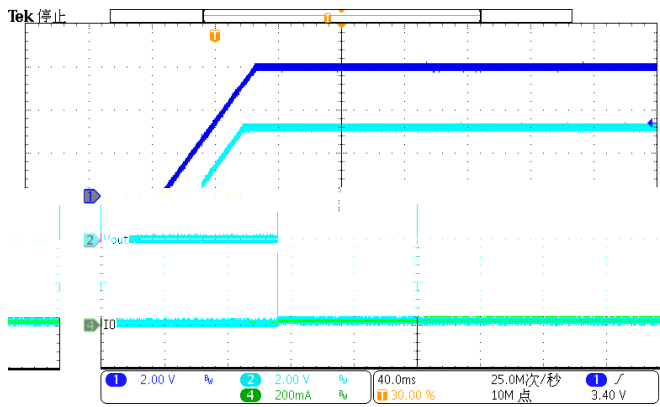
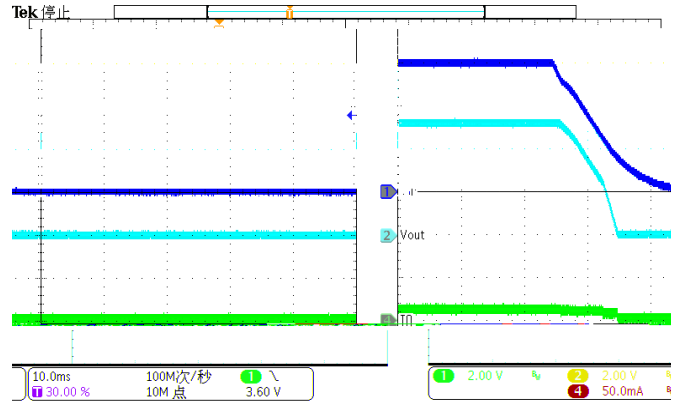
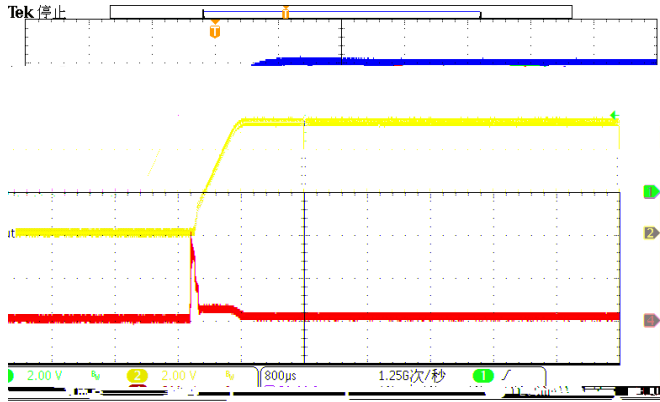

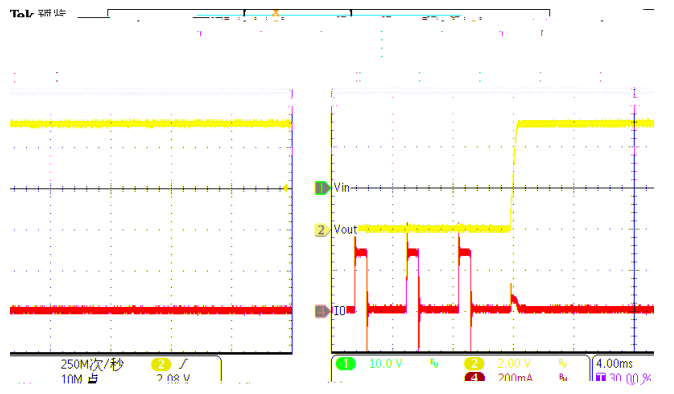
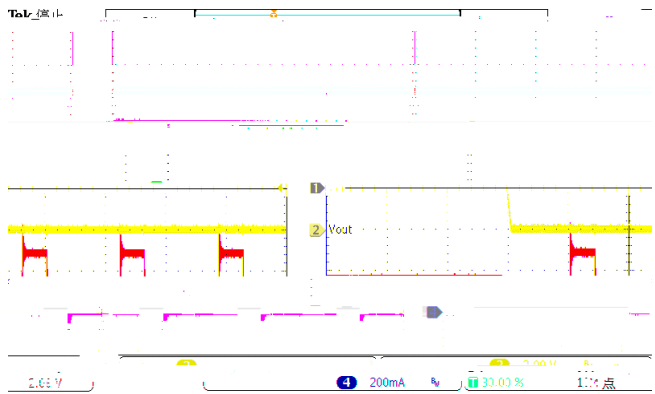
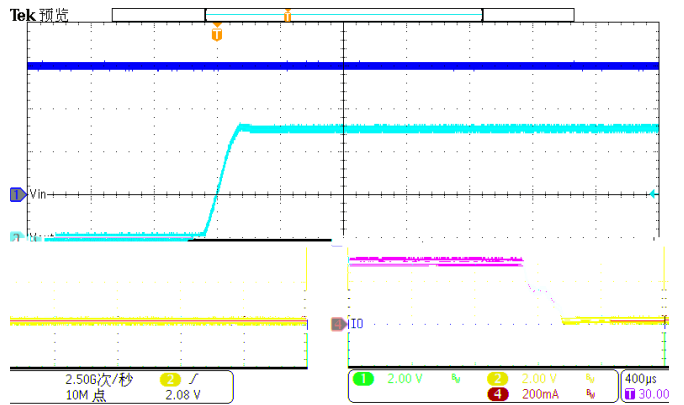
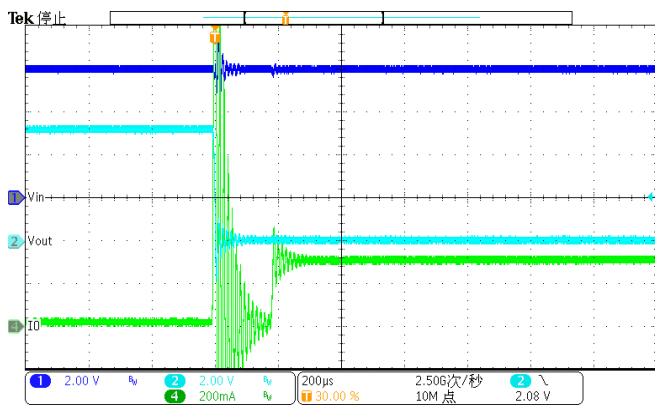
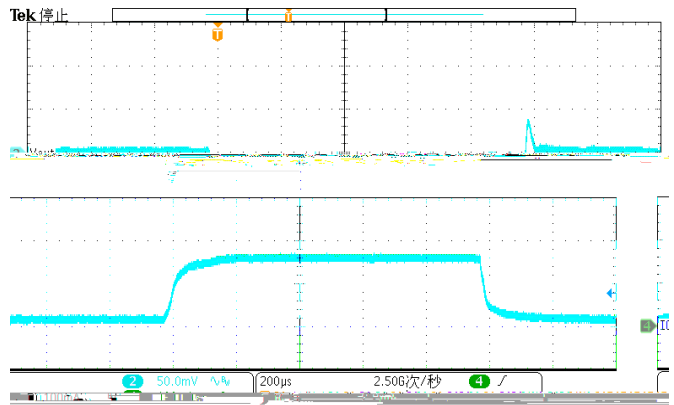
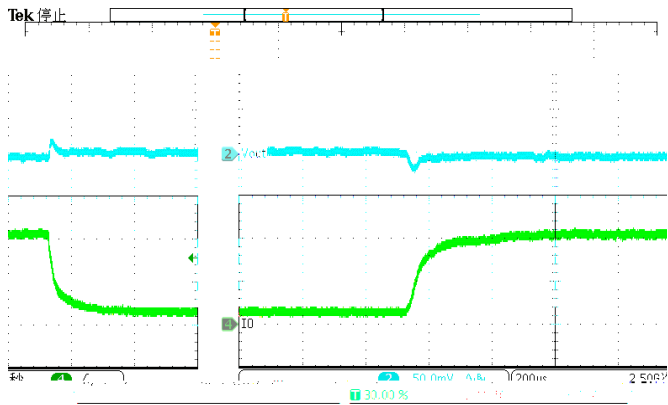

- 1.
- 2.
- 3.
- 4.
- 5.

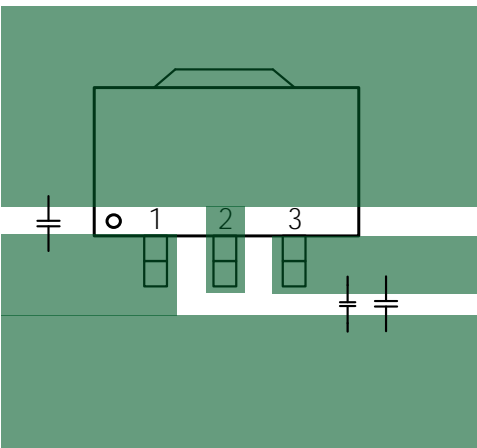
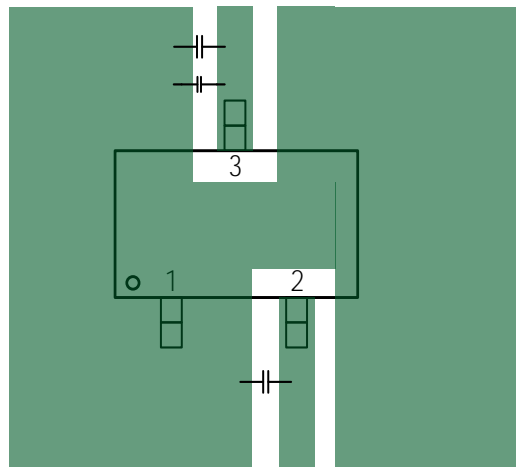
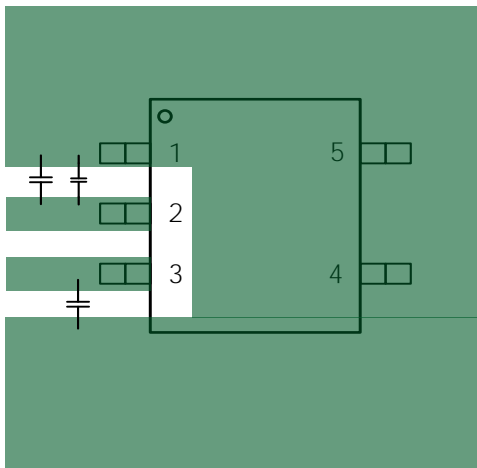

BDLBHFAOGP NB PO

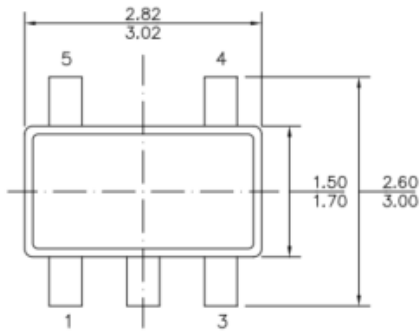

TOP VIEW

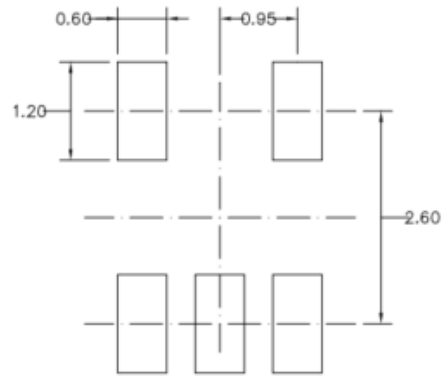

RECOMMENDED LAND PATTERN



FRONT VIEW

SIDE VIEW

NOTE:

1) ALL DIMENSIONS ARE IN MILLIMETERS.
 2) PACKAGE LENGTH DOES NOT INCLUDE MOLD FLASH, PROTRUSION OR GATE BURR.
 3) PACKAGE WIDTH DOES NOT INCLUDE INTERLEAD FLASH OR PROTRUSION.
 4) LEAD COPLANARITY (BOTTOM OF LEADS AFTER FORMING) SHALL BE 0.10 MILLIMETERS MAX.
 5) DRAWING CONFORMS TO JEDEC MO-19 VARIATION AA.
 6) DRAWING IS NOT TO SCALE.

DETAIL A

- 1.
 - 2.
 - 3.
 - 4.
 - 5.
 - 6.
- A**

A

BDLBHFAOGP NB PO

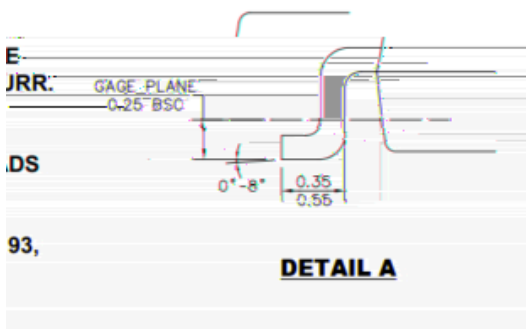
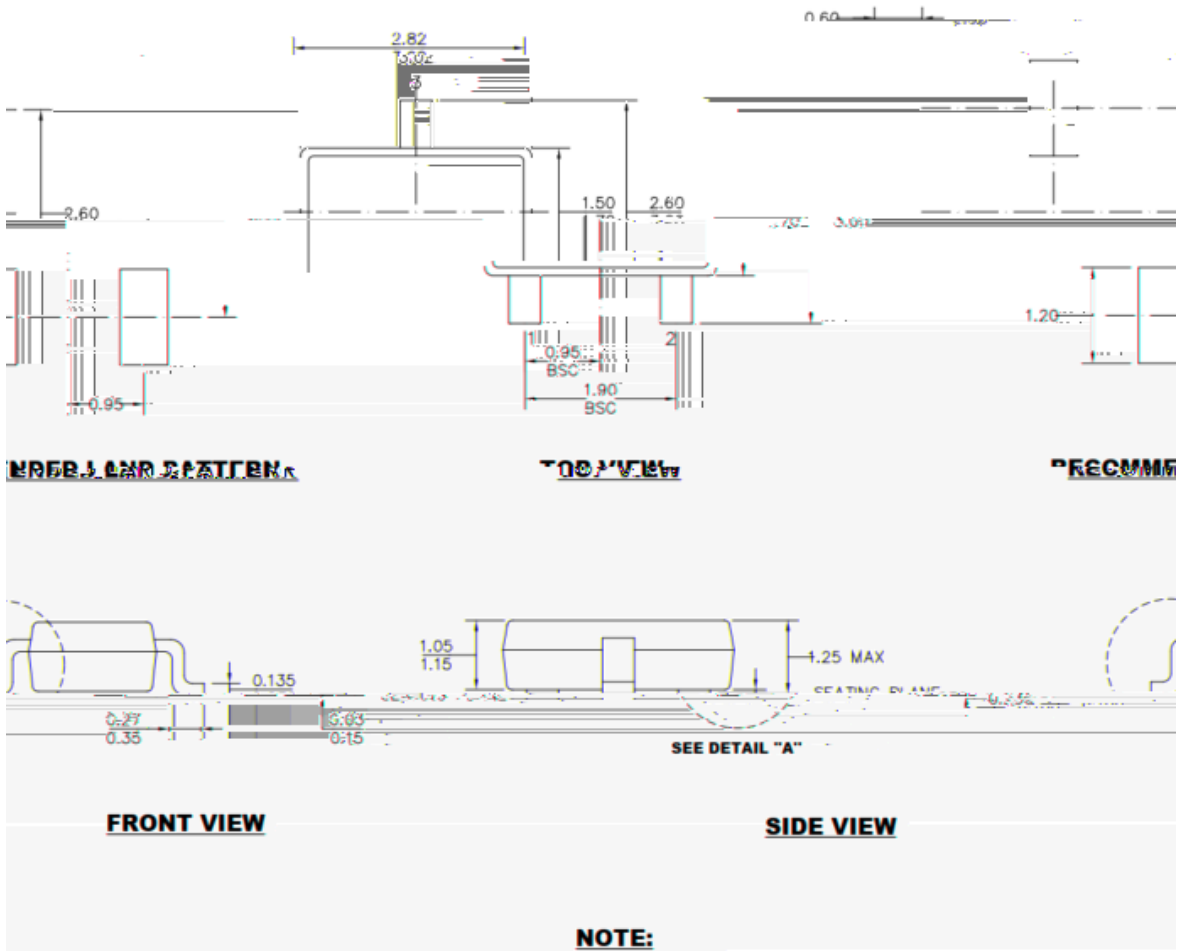

- NOTE:**
- 1) ALL DIMENSIONS ARE IN MILLIMETERS.
 - 2) PACKAGE LENGTH DOES NOT INCLUDE MOLD FLASH, PROTRUSION OR GATE BURR.
 - 3) PACKAGE WIDTH DOES NOT INCLUDE INTERLEAD FLASH OR PROTRUSION.
 - 4) LEAD COPLANARITY (BOTTOM OF LEAD AFTER FORMING) SHALL BE 0.10 MILLIMETERS MAX.
 - 5) DRAWING CONFORMS TO JEDEC MO-1 VARIATION AA.
 - 6) DRAWING IS NOT TO SCALE.

1.
2.
3.
4.
5.
6.
A

A

BDLBHFAOGP NB PO

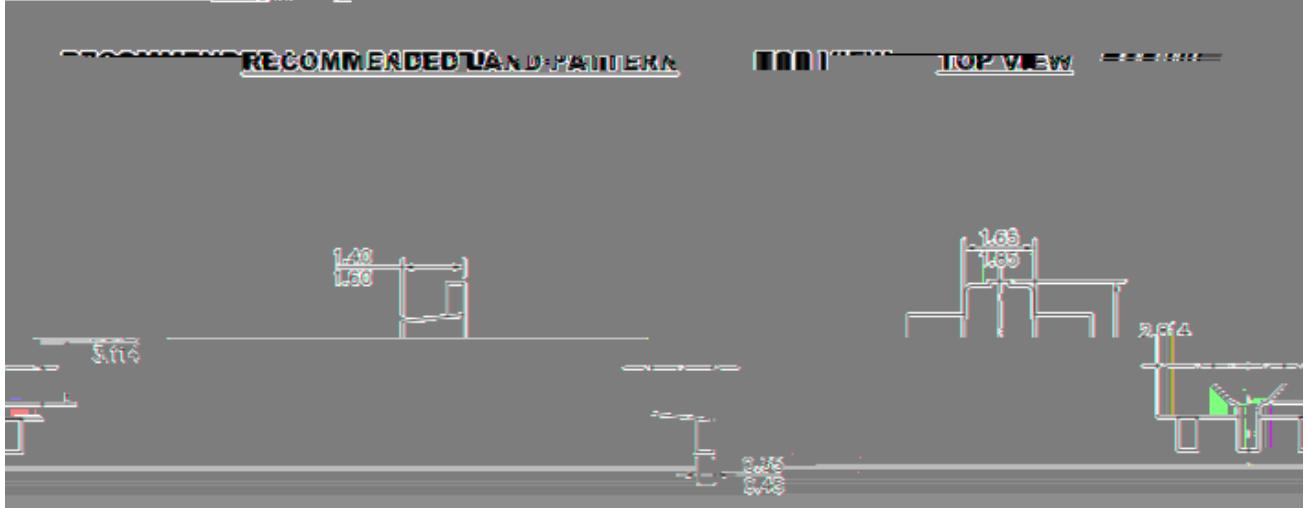
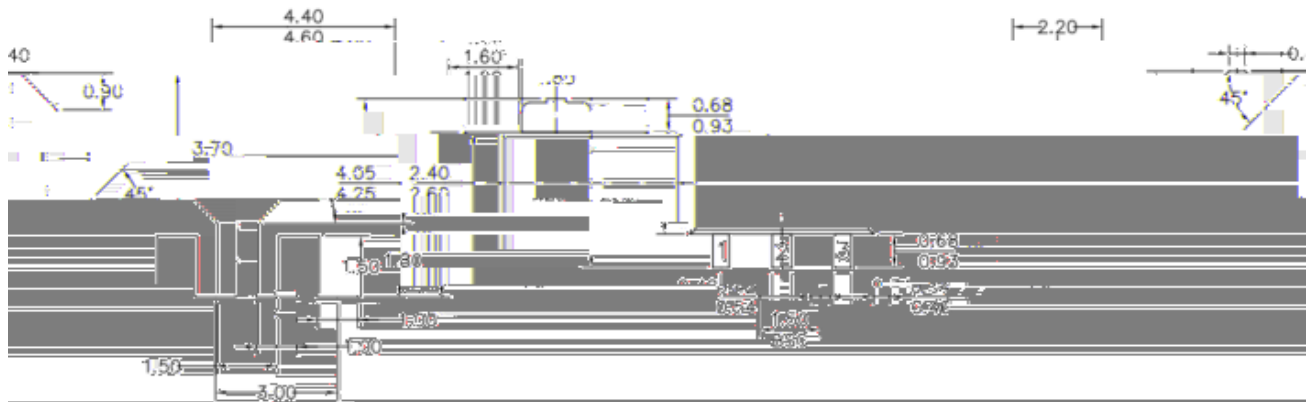

VIEW **SIDE-VIEW** **BOTTOM VIEW**

NOTE:

- 1) ALL DIMENSIONS ARE IN MILLIMETERS.
- 2) DATA REFERENCE IS TO 2D.
- 3) DRAWING IS NOT TO SCALE.

- 1.
- 2.
- 3.
- 4.
- 5.
- 6.

A

A

B FBOEA FFMAOGP NB POA

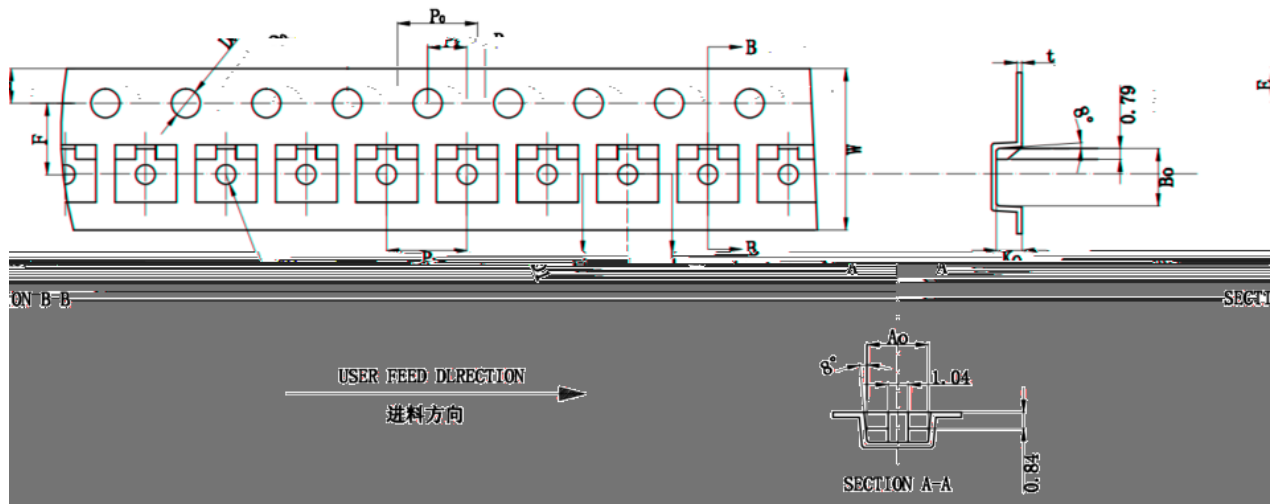
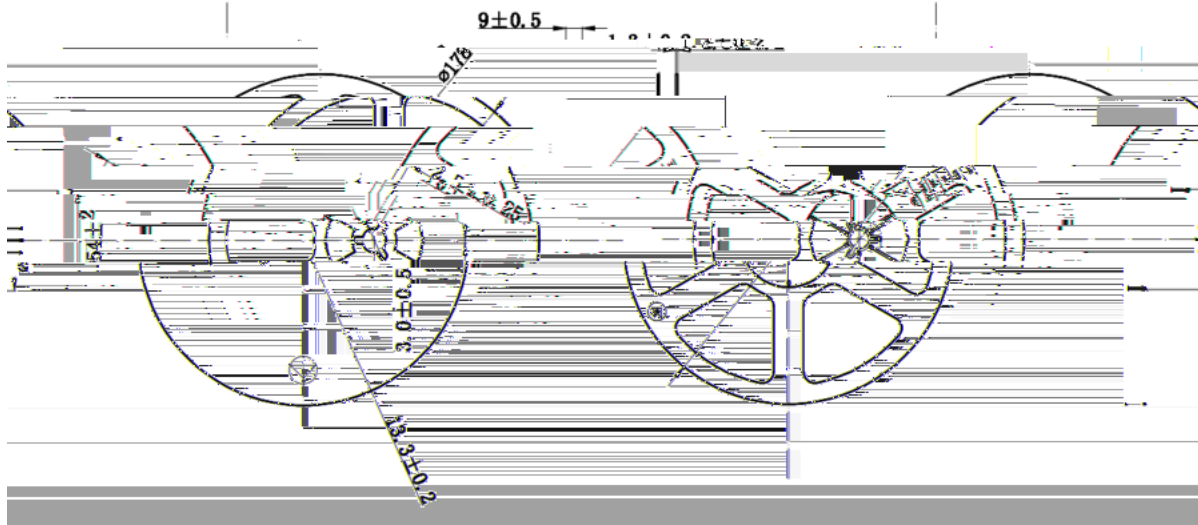

ITEM	W	A ₀	B ₀	K ₀	E	F	D ₁	D ₀	P ₀	P ₁	P ₂	t
1												
2												
3												
4												
5												
6												

- 注:
- 任意10个齿轮的累计误差不得超过±0.2mm
 - 材料厚度以载带边缘测量为准;
 - 载带长度方向100mm距离的非平行度不得超过1mm; 超过250mm不计算累计误差;
 - 若非指明, 公差范围为: ±0.1mm
 - A₀、B₀为型腔内侧最底部向上0.3mm处测量为准; K₀为内部深度;
 - 型腔外形凡未标明处倒角R为0.2-0.3;

B FBOEA FFMAOGP NB POA

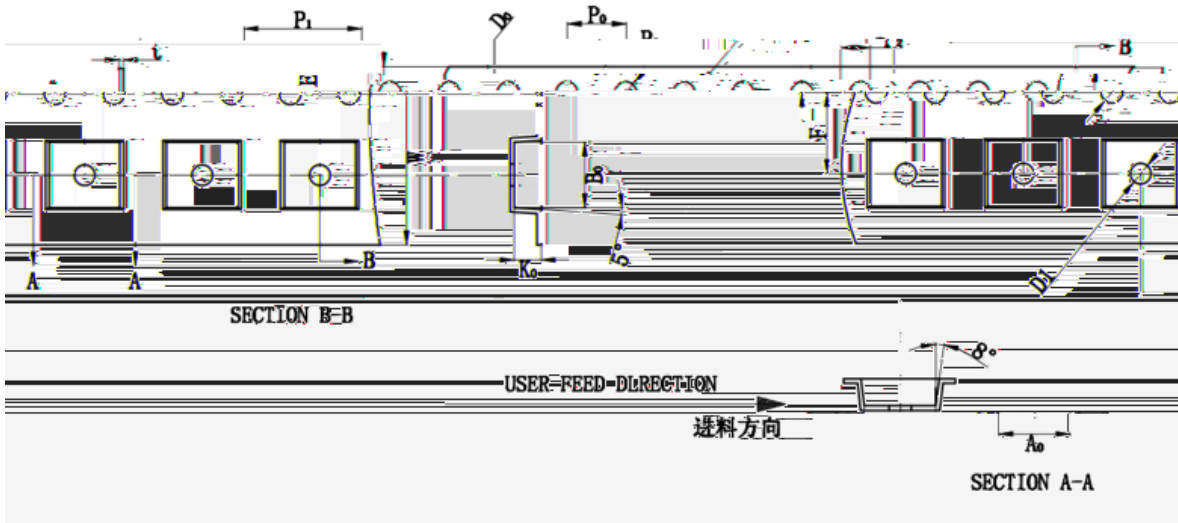
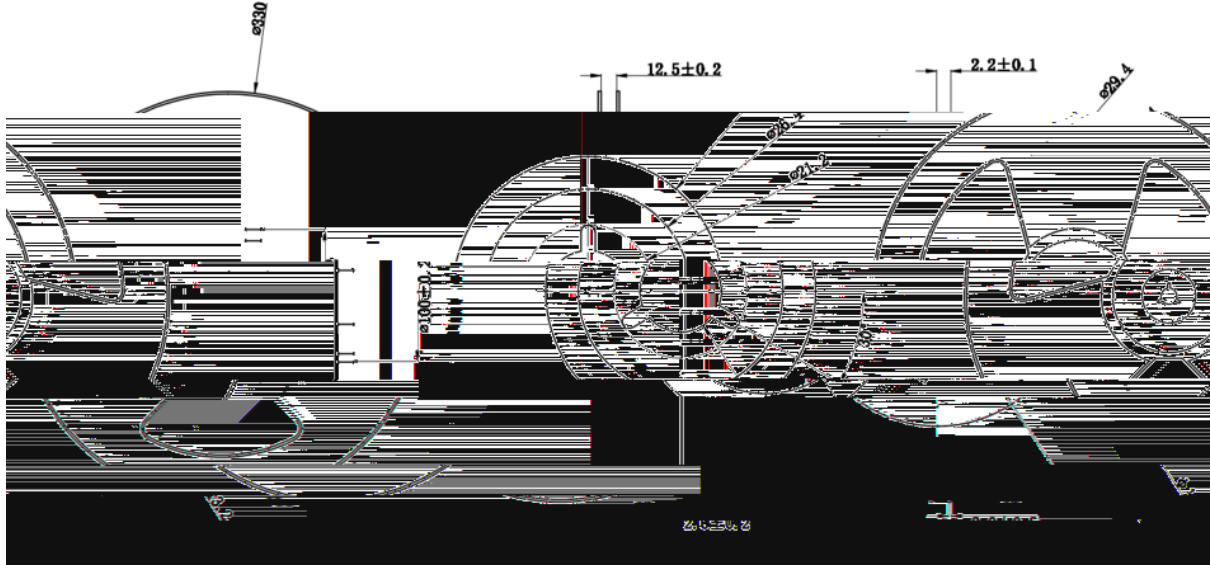

ITEM	W	A ₀	B ₀	K ₀	E	F	D ₁	D ₂	P ₂	P ₁	P ₂	t

- 注:
- 任意10个齿轮的累计误差不得超过±0.2mm
 - 材料厚度以载带边缘测量为准;
 - 载带长度方向100mm距离的非平行度不得超过1mm; 超过250mm不计算累计误差;
 - 除非指明, 公差范围为: ±0.1mm
 - A₀、B₀为型腔内侧最底部向上0.3mm处测量为准, K₀为内部深度;
 - 型腔外形凡未标明处倒角R为0.2-0.3;